

CENTRO DE INVESTIGACIÓN Y TECNOLOGÍA AGROALIMENTARIA DE ARAGÓN - Biblioteca



Boletín de información bibliográfica
Sumarios de monografías nº 1
Enero 2015

Q-5-258**Centro de Investigación y Formación Agrarias**

Memoria de actividades : año 2013 / Centro de Investigación y Formación Agrarias

1. MEMORIAS 2. CANTABRIA 3. PROYECTOS DE INVESTIGACION 4. INSTITUCIONES DE INVESTIGACION I. TITULO
2000005582

Q-6-3961

CLIMATE change and sustainable development : ethical perspectives on land use and food production : EurSAFE2012 Tübingen, Germany, 30 May - 2 June 2012 / edited by, Thomas Potthast, Simon Meisch

1. CAMBIO CLIMATICO 2. SOSTENIBILIDAD 3. UTILIZACION DE LA TIERRA 4. ALIMENTOS 5. CONGRESOS I. Potthast, Thomas II. European Society for Agricultural and Food Ethics (EurSAFE) (2012. Tübingen, Germany)
2000005583

R-6-406

El GARBANZO :un cultivo para el siglo XXI / obra colectiva coordinada y dirigida por José del Moral de la Vega, Ángel Mejías Guisado ; Luis E. Bernardo Carrascal ...[et. al]

1. GARBANZO 2. CULTIVO I. Moral de la Vega, José del II. Mejías Guisado, A.
2000005584

R-6-407**Congreso Tecnológico del Tomate para Industria (1º. 12-13 noviembre. Badajoz)**

1º Congreso Tecnológico del Tomate para Industria 12-13 noviembre, Palacio de Congresos de Badajoz "Manuel Rojas" / organiza, Observatorio Tecnológico del Tomate, Plataforma Tecnológica del Sector de Tomate de Industria; [investigaciones],CTAEX

1. TOMATE 2. CULTIVO 3. SECTOR AGROINDUSTRIAL 4. CONGRESOS I. Observatorio Tecnológico del Tomate II. Centro Tecnológico Agroalimentario III. TITULO
2000005585

T-6-330**Fontanet Roig, Xavier**

Plagas y enfermedades en hortalizas y frutales ecológicos :prevenir, identificar y tratar con métodos ecológicos / Xavi Fontanet i Roig y Andreu Vila Pascual

1. PLAGAS DE PLANTAS 2. HORTALIZAS 3. FITOPATOLOGIA 4. CULTIVO I. Vila Pascual, Andreu II. TITULO
2000005586

W-4-458

SOIL water / edited by D.R. Nielsen... [et al.]

1. AGUAS SUBTERRANEAS 2. CONTENIDO DE AGUA EN EL SUELO I. Nielsen, D.R.
2000005562

W-4-459**Todd, David Keith**

Ground water hydrology / David Keith Todd

1. AGUAS SUBTERRANEAS 2. HIDROGEOLOGIA I. TITULO
2000005563

W-4-460

Linsley, Ray K.

Hydrology for engineers / Ray K. Linsley, Max A. Kohler, Joseph L.H. Paulhus. -- 2^a ed

(McGraw-Hill series in water resources and environmental engineering)

1. HIDROGEOLOGIA I. TITULO II. SERIE

2000005564

W-4-461

WATER : the yearbook of agriculture 1955 / The United States Department of Agriculture

1. AGUA 2. AGRICULTURA 3. EUA I. United States Department of Agriculture

2000005565

W-4-462

DRAINAGE manual : a water resources technical publication / United States Department of the Interior

1. DRENAJE 2. RIEGO I. United States Department of the Interior

2000005566

W-4-463

Framji, K.K.

Irrigation and drainage in the world : a global review / by K.K. Framji and I.K. Mahajan. -- 2^a ed

1. RIEGO 2. DRENAJE I. TITULO

2000005567

W-4-464

Framji, K.K.

Irrigation and drainage in the world : a global review / by K.K. Framji and I.K. Mahajan. -- 2^a ed

1. RIEGO 2. DRENAJE I. TITULO

2000005567

W-4-465

Hanks, R.J.

Modeling crop responses o irrigation : in relation to soils, climate and salinity / R.J. Hanks and R.W. Hill

(International Irrigation Information Center. IIC publications ; 6)

1. AGRICULTURA DE REGADIO 2. SUELOS AGRICOLAS 3. RIEGO 4. MODELOS DE SIMULACION I. TITULO II. SERIE

2000005568

W-4-466

IRRIGATION of field and orchard crops under semi-arid conditions / compiled and edited by J. Shalhevet... [et al.]. -- 2^a rev. ed

(International Irrigation Information Center. IIC publications ; 1)

1. RIEGO 2. ZONA SEMIARIDA I. Shalhevet, J. II. SERIE

2000005569

W-4-467

DESIGN of small canal structures, 1978 : engineering technology pertaining primarily to the design of small canal structures of less than 100-cubic-feet-per-second capacity / by A. J. Aisenbrey, ... [et al.]. -- rev. reprint

1. CANALES 2. CONSTRUCCIONES HIDRAULICAS 3. INGENIERIA HIDRAULICA I. Aisenbrey, A. J.

2000005570

W-4-468

García Lozano, Faustino

Medición del agua de riego / Faustino García Lozano

Incluida en el Programa de Publicaciones Oficiales del Ministerio de Obras Públicas y Urbanismo para 1978, aprobado por la Secretaria General Técnica del Departamento, publicación número 127

1. AGUA DE RIEGO 2. MEDICION I. TITULO 2000005571

X-3-463.130

Carrillo García, Germán

Desarrollo rural y cooperativismo agrario en Ecuador : trayectorias históricas de los pequeños productores en la economía global / Germán Carrillo García

(Estudios / MAPA ; 178)

1. DESARROLLO RURAL 2. ASOCIACIONES DE AGRICULTORES 3. ECUADOR I.

2000005581

X-3-923

MIRAR el paisaje para contemplar nuestra historia : 100 años de cambios en el paisaje de Riegos del Alto Aragón / [Riegos del Alto Aragón]

1. PAISAJE 2. TIERRAS AGRICOLAS 3. COMUNIDADES DE REGANTES 4. ARAGON 5. HISTORIA I. Comunidad General de Riegos del Alto Aragón

2000005573

June 1977
August 1977
Davis Ca,

SOIL WATER

Edited by

D. R. NIELSEN
R. D. JACKSON, J. W. CARY, D. D. EVANS

Written by

L. BOERSMA, J. W. CARY, D. D. EVANS,
A. H. FERGUSON, W. H. GARDNER, R. J. HANKS,
R. D. JACKSON, W. D. KEMPER, D. E. MILLER,
D. R. NIELSEN, G. UEHARA

American Society of Agronomy
Soil Science Society of America
677 South Segoe Road
Madison, Wisconsin
53711

TABLE OF CONTENTS

	Page
CHAPTER 1 – THE SOIL-WATER SYSTEM	
Complexity of the Soil-Water System	2
Direction of Effort	2
Physical and Mathematical Concepts	3
CHAPTER 2 – SOLID AND FLUID PROPERTIES OF THE SOIL-WATER SYSTEM	
The Solid Framework	5
Size and Shape of Particles	5
Arrangement of Particles that Form Pore Walls	6
Particle Migration, Swelling, and Shrinkage	7
Soil Water	12
Solid-Liquid Interface	15
Soil Air	17
Future Research Effort	18
Literature Cited	19
CHAPTER 3 – THEORETICAL ANALYSIS	
Soil-Water Potential	21
Equilibrium thermodynamic approach	23
Measurement of potentials	24
Hydrodynamics	25
Momentum balance	26
Darcy's equation	29
Equation of continuity	29
Unsaturated conditions	30
Diffusion-type equations	30
Diffusion	31
Diffusion in porous materials	31
Dispersion	36
Electrostatics	39
Gouy theory	39
The fully extended diffuse layer	42
Interacting diffuse layers	43
Electrokinetics	47
Temperature and Osmotic Induced Flow	50
Temperature gradient	50
Osmotic gradients	50

Nonequilibrium Thermodynamics	50
Entropy change and flux components	51
Evaluation of entropy change	51
Examples of flux components	54
Fourier and Darcy's equations	57
Transient systems	58
Future Research Effort	60
Literature Cited	62

CHAPTER 4 – WATER MOVEMENT UNDER ISOTHERMAL CONDITIONS

Hydraulic Conductivity and Water Characteristic Measurements	64
Nonsteady-State Methods	67
Calculations of Hydraulic Conductivity Based	
Upon Soil-Water Characteristics	72
Vertical Infiltration	74
Hysteresis	75
Redistribution Following Infiltration	77
Water Vapor Flow	78
Computer Techniques	80
Approximate and Semi-Empirical Analyses	81
Heterogeneous Soils	83
Heterogeneous Water Content Distributions	87
Displacement of Air	88
Future Research Effort	90
Literature Cited	91

CHAPTER 5 – THE EFFECT OF TEMPERATURE ON UNSATURATED SOIL WATER TRANSPORT

The Importance of Soil Temperature	98
A Modified Diffusion Equation	99
Application of Non-equilibrium Thermodynamics	101
Thermally Induced Water Flow	101
Equation of Q' and Q''	102
Estimating Water Vapor Transport	105
Measurement of β	107
Thermally Induced Flow in Water-Saturated Soil	108
Significance of Q'	109
A Laboratory Apparatus for Measuring Fluxes of Heat and Water	110
Calculations of Water Vapor Flux for Non-Steady	
Temperature Conditions	112
Future Research Effort	117
Literature Cited	119

**CHAPTER 6 – ISOTHERMAL FLOW OF NONHOMOGENEOUS
AQUEOUS SOLUTIONS**

Miscible Displacement Apparatus	122
Dispersion Coefficient Values	123
Leaching Unsaturated Soils	125
Solute Movement Within a Uniform Profile	126
Restricted Flow of Solutes	127
Flow Between Two Solid Surfaces	128
Salt Sieving Across a Clay	131
The Significance of Salt Sieving	136
The Nature of Osmotically Induced Water Flow	137
Reflection Probability	138
Measuring Osmotic Efficiency Coefficients	141
Details For Estimating σ	147
Future Research Effort	151
Literature Cited	153

CHAPTER 7 – FIELD INVESTIGATIONS

Laboratory-Determined Parameters Applied to the Field	155
Tensiometers	156
Field Measurement of Hydraulic Conductivity and Soil-Water Characteristics	156
Field Methods for Obtaining Approximate Values of Conductivity	159
Prediction of Soil-Water Flux	160
Prediction of Soil-Water Profiles	162
Water Flux in the Presence of Annual Temperature Changes	164
Water Flux in the Presence of Diurnal Temperature Changes	165
Water Flux with a Growing Crop	167
Direct Soil-Water Flux Measurement	168
Leaching and Displacing the Soil Solution	169
A Unique Field Use of Soil Water	171
Future Research Effort	171
Literature Cited	173

New York : John Wiley & Sons, Inc.

GROUND
WATER

Hydrology.....

London · Sydney

Joe Fain

David, CA Nov 22, 77

.....**David Keith Todd, Ph.D.**

ASSOCIATE PROFESSOR OF CIVIL ENGINEERING
UNIVERSITY OF CALIFORNIA, BERKELEY

Contents



1	Introduction	1
	Scope. Historical Background. Utilization of Ground Water. Ground Water in the Hydrologic Cycle. Literature and Data Sources	
2	Occurrence of Ground Water	14
	Origin of Ground Water. Rock Properties Affecting Ground Water. Vertical Distribution of Ground Water. Geologic Formations as Aquifers. Types of Aquifers. Ground Water Basins. Springs. Ground Water in Permafrost Regions. Ground Water in the United States	
3	Ground Water Movement	44
	Darcy's Law. Coefficient of Permeability. Ground Water Flow Rates. Permeability Formulas. Laboratory Measurement of Permeability. Field Measurement of Permeability. Tracing Ground Water Movement. General Flow Equations. Ground Water Flow Lines. Unsaturated Flow.	

4	Ground Water and Well Hydraulics	78
	Steady Unidirectional Flow. Steady Radial Flow to a Well Well in a Uniform Flow Steady Flow with Uniform Recharge Unsteady Radial Flow to a Well Nonequilibrium Equation for Pumping Tests. Well Flow Near Aquifer Boundaries. Multiple Well Systems Partially Penetrating Wells. Characteristic Well Losses.	
5	Water Wells	115
	Test Holes and Well Logs Methods for Constructing Shallow Wells. Methods for Drilling Deep Wells Well Completion. Well Development. Testing Wells for Yield Pumping Equipment Sanitary Protection of Wells. Maintenance and Repair of Wells. Collector Wells Infiltration Galleries.	
6	Ground Water Levels and Fluctuations	149
	Secular and Seasonal Variations. Streamflow and Ground Water Levels. Fluctuations Due to Evapotranspiration Fluctuations Due to Meteorological Phenomena. Fluctuations Due to Tides, External Loads, and Earthquakes. Control by Drains and Wells.	
7	Quality of Ground Water	177
	Sources of Salinity. Ground Water Samples. Measures of Water Quality. Chemical Analysis Physical Analysis. Bacterial Analysis. Water Quality Criteria. Base Exchange. Deterioration of Ground Water Quality Temperature.	
8	Basin-Wide Ground Water Development	200
	Safe Yield and Overdraft Factors Governing Safe Yield. Equation of Hydrologic Equilibrium Data Collection for	

Basin Investigations Methods of Computing Safe Yield. Variability of Safe Yield. Conjunctive Use of Surface and Ground Water Reservoirs.

9 Surface Investigations of Ground Water 219

Geophysical Exploration. Electrical Resistivity Method. Seismic Refraction Method. Gravity and Magnetic Methods. Geologic Methods. Air Photo Interpretation. Dowsing.

10 Subsurface Investigations of Ground Water 235

Test Drilling. Resistivity Logging. Potential Logging. Temperature Logging. Caliper Logging. Other Subsurface Methods.

11 Artificial Recharge of Ground Water 251

Artificial Recharge in the United States. Water Spreading. Research on Water Spreading. Sewage Recharge. Recharge through Pits and Shafts. Recharge through Wells. The Manhattan Beach Recharge Project. Recharge Wells on Long Island, New York. Recharge Wells for Storm Drainage. Induced Recharge. European Recharge Practices.

12 Sea Water Intrusion in Coastal Aquifers 277

Occurrence of Sea Water Intrusion. Ghyben-Herzberg Relation between Fresh and Saline Waters. Shape of the Fresh-Salt Water Interface. Length of the Intruded Sea Water Wedge. Structure of the Fresh-Salt Water Interface. Prevention and Control of Sea Water Intrusion. Field Tests for Controlling Intrusion at Manhattan Beach, California. Fresh-Salt Water Relations on Oceanic Islands. Recognition of Sea Water in Ground Water.

13	Legal Aspects of Ground Water	297
	Systems of Title to Ground Water. Legal Interpretation of Ground Water. Ground Water Law in the United States. Water Rights in Overdraft Areas. Statutory Control of Recharged Ground Water. Common Regulations Applying to Ground Water.	
14	Model Studies and Numerical Analysis of Ground Water	307
	Sand Models. Electrical Models. Viscous Fluid Models. Membrane Models. Numerical Analysis Methods.	
	Appendix	327
	Conversion Factors and Constants	
	Index	329

McGRAW-HILL
BOOK COMPANY

New York
St. Louis
San Francisco
Düsseldorf
Johannesburg
Kuala Lumpur
London
Mexico
Montreal
New Delhi
Panama
Paris
São Paulo
Singapore
Sydney
Tokyo
Toronto

Jose Fari

Davis, Ca

Jan, 5, 78

RAY K. LINSLEY, JR.

*Professor of Hydraulic Engineering
Stanford University
Chairman, Hydrocomp, Inc*

MAX A. KOHLER

*Consulting Hydrologist
Formerly Associate Director, Hydrology
U.S. National Weather Service*

JOSEPH L. H. PAULHUS

*Consulting Hydrometeorologist
Formerly Chief, Water Management Information Division
U.S. National Weather Service*

Hydrology for Engineers

SECOND EDITION

CONTENTS

Preface	xvii
List of Symbols and Abbreviations	xix
1 Introduction	1
1-1 The Hydrologic Cycle	2
1-2 History	4
1-3 Hydrology in Engineering	5
1-4 Subject Matter of Hydrology	5
References	6
Bibliography	6
Problems	7
2 Weather and Hydrology	8
<i>Solar and Earth Radiation</i>	9
2-1 Solar and Earth Radiation	9
2-2 Solar Radiation at Earth's Surface	9
2-3 Heat Balance of Earth's Surface and Atmosphere	10
2-4 Measurement of Radiation	14

<i>The General Circulation</i>	15
2-5 Thermal Circulation	15
2-6 Effects of Earth's Rotation	15
2-7 Jet Streams	17
2-8 Effect of Land and Water Distribution	20
2-9 Migratory Systems	20
2-10 Fronts	23
<i>Temperature</i>	26
2-11 Measurement of Temperature	26
2-12 Terminology	28
2-13 Lapse Rates	29
2-14 Geographic Distribution of Temperature	30
2-15 Time Variations of Temperature	32
<i>Humidity</i>	32
2-16 Properties of Water Vapor	32
2-17 Terminology	34
2-18 Measurement of Humidity	38
2-19 Geographic Distribution of Humidity	39
2-20 Time Variations in Humidity	39
<i>Wind</i>	40
2-21 Measurement of Wind	41
2-22 Geographic Variation of Wind	41
2-23 Time Variation of Winds	46
References	46
Bibliography	49
United States Data Sources	52
Problems	53
3 Precipitation	55
3-1 Formation of Precipitation	56
3-2 Forms of Precipitation	59
3-3 Types of Precipitation	61
3-4 Artificially Induced Precipitation	62
<i>Measurement of Precipitation</i>	65
3-5 Precipitation Gages	66
3-6 The Precipitation-Gage Network	73
3-7 Radar Measurement of Precipitation	76
3-8 Satellite Estimates of Precipitation	79

	<i>Interpretation of Precipitation Data</i>	79
3-9	Estimating Missing Precipitation Data	80
3-10	Double-Mass Analysis	81
3-11	Average Precipitation over Area	82
3-12	Depth-Area-Duration Analysis	84
	<i>Variations in Precipitation</i>	85
3-13	Geographic Variations	85
3-14	Time Variations	87
3-15	Record Rainfalls	89
	<i>Snowpack and Snowfall</i>	92
3-16	Measurement	92
3-17	Variations	98
	References	98
	Bibliography	103
	United States Data Sources	106
	Problems	108
4	Streamflow	110
	<i>Water Stage</i>	110
4-1	Manual Gages	110
4-2	Recording Gages	112
4-3	Crest-Stage Gages	114
4-4	Miscellaneous Stage Gages	115
4-5	Selection of Station Site	116
	<i>Discharge</i>	116
4-6	Current Meters	116
4-7	Current-Meter Measurements	119
4-8	Chemical Gaging	123
4-9	Stage-Discharge Relations	123
4-10	Extension of Rating Curves	127
4-11	Effect of Ice on Streamflow	128
4-12	Other Methods of Obtaining Streamflow Data	129
4-13	Planning a Streamflow Network	130
	<i>Interpretation of Streamflow Data</i>	131
4-14	Units	131
4-15	Hydrographs	132
4-16	Mean Daily Flows	133
4-17	Adjustment of Streamflow Data	133
4-18	Mean Annual Runoff	137

8	Relations between Precipitation and Runoff	257
	<i>The Phenomena of Runoff</i>	257
8-1	Surface Retention	257
8-2	Infiltration	260
8-3	The Runoff Cycle	262
	<i>Estimating the Volume of Storm Runoff</i>	265
8-4	Initial Moisture Conditions	265
8-5	Storm Analysis	266
8-6	Multivariate Relations for Total Storm Runoff	267
8-7	Relations for Incremental Storm Runoff	270
8-8	Runoff Estimates Using Infiltration	272
8-9	Infiltration Indexes	273
	<i>Estimating Snowmelt Runoff</i>	274
8-10	Physics of Snowmelt	274
8-11	Estimating Snowmelt Rates and Consequent Runoff	277
	<i>Seasonal and Annual Runoff Relations</i>	278
8-12	Precipitation-Runoff Relations	278
8-13	Use of Snow Surveys	280
	References	282
	Bibliography	283
	Problems	284
9	Streamflow Routing	287
9-1	Wave Movement	288
9-2	Dynamic and Kinematic Waves	291
9-3	Waves in Natural Channels	292
9-4	The Storage Equation	294
9-5	Determination of Storage	295
9-6	Reservoir Routing	298
9-7	Routing in River Channels	299
9-8	Streamflow Routing: Analytical Method	300
9-9	Streamflow Routing: Graphical Methods	303
9-10	Dynamic and Kinematic Routing	305
9-11	Deriving Basin Outflow by Routing	308
9-12	Gage Relations	311
	References	314
	Bibliography	316
	Problems	316

10	Computer Simulation of Streamflow	319
10-1	Philosophy of Simulation	320
10-2	Structure of a Flow-Simulation Program	321
10-3	Parameters	326
10-4	Simulation of Snowmelt	327
10-5	Application of Flow Simulation in Hydrology	330
10-6	Calibration and Optimization	332
10-7	Other Applications of Simulation in Hydrology	334
	References	335
	Bibliography	336
	Problems	337
11	Probability in Hydrology: A Basis for Design	338
	<i>Flood Probability</i>	339
11-1	Selection of Data	339
11-2	Plotting Positions	340
11-3	Theoretical Distribution of Floods	342
11-4	Log-Pearson Type III Distribution	343
11-5	Extreme-Value Type I Distribution	345
11-6	Selection of Design Frequency	349
11-7	Regional Flood Frequency	350
11-8	Frequency Analysis from Synthetic Data	352
11-9	Conditional Probability	353
11-10	Frequent Events	355
	<i>Precipitation Probability</i>	356
11-11	Distributions	356
11-12	Generalization of Rainfall-Frequency Data	356
11-13	Adjustment of Fixed-Interval Precipitation Amounts	357
11-14	Rainfall-Frequency Maps	359
11-15	Design Storm	360
	<i>Probability of Runoff Volume</i>	360
11-16	Distributions	360
11-17	Drought	360
	<i>Probable Maximum Events</i>	361
11-18	Hydrometeorological Studies	361
11-19	Probable Maximum Flood	363
	References	368
	Bibliography	371
	United States Data Sources	372
	Problems	372

12 Stochastic Hydrology	374
<i>12-1</i> The Stochastic Generator	376
<i>12-2</i> Distribution of t	378
<i>12-3</i> Definition of Parameters	379
<i>12-4</i> The Hurst Phenomenon	385
<i>12-5</i> The Storage Model	386
<i>12-6</i> Storage Requirement from Stochastic Data	387
<i>12-7</i> Reservoir Reliability	391
<i>12-8</i> Time Trends	392
<i>12-9</i> Multistation Models	393
<i>12-10</i> Stochastic Analysis of Precipitation	394
References	397
Bibliography	398
Problems	398
13 Sedimentation	399
<i>13-1</i> The Erosion Process	399
<i>13-2</i> Factors Controlling Erosion	400
<i>13-3</i> Suspended-Sediment Transport	401
<i>13-4</i> Bed-Material Transport	403
<i>13-5</i> Sediment Measurement	405
<i>13-6</i> Sediment-Rating Curves	407
<i>13-7</i> Sediment Yield of a Watershed	408
<i>13-8</i> Sediment Simulation	410
<i>13-9</i> Reservoir Sedimentation	411
References	414
Bibliography	415
Problems	415
14 Morphology of River Basins	417
<i>14-1</i> Physical Descriptors of Watershed Form	418
<i>14-2</i> Descriptors of Watershed Relief	420
<i>14-3</i> Hydraulic Geometry	423
<i>14-4</i> Stream Patterns	425
<i>14-5</i> Flood plains	428
References	428
Bibliography	429
Problems	430

Appendixes	431
<i>A</i> Graphical Correlation	431
<i>B</i> Tables of Physical Constants and Equivalents and Psychrometric Tables	443
<i>C</i> Evaporation Computation Charts in Metric Units	457
Indexes	463
Name Index	
Subject Index	

THE
YEARBOOK
OF
AGRICULTURE
1955

WATER

THE
UNITED STATES
DEPARTMENT
OF
AGRICULTURE

Contents



Our Need for Water

- 1 The Story of Water as the Story of Man, *Bernard Frank*
- 9 Necessary, Convenient, Commonplace, *Sterling B Hendricks*
- 14 Animals and Fowl and Water, *Joseph F Sykes*
- 18 The Needs and Uses of Water by Plants, *Leon Bernstein*
- 25 Water and the Micro-organisms, *Paul R. Miller and Francis E. Clark*
- 35 Trends in the Utilization of Water, *Karl O Kohler, Jr*

Where We Get Our Water

- 41 From Ocean to Sky to Land to Ocean, *William C. Ackermann, E. A. Colman, and Harold O. Ogrosky*
- 52 The Water in the Rivers and Creeks, *W. B. Langbein and J. V. B. Wells*
- 62 Underground Sources of Our Water, *Harold E. Thomas*
- 78 How We Measure the Variations in Precipitation, *William E. Hiatt and Robert W. Schloemer*
- 84 Is Weather Subject to Cycles? *Ivan R. Tannehill*
- 91 Hauling Down More Water From the Sky, *Chas Gardner, Jr.*
- 95 Measuring Snow To Forecast Water Supplies, *R. A. Work*
- 103 Fog, Mist, Dew, and Other Sources of Water, *F. W. Went*
- 109 Conversion of Saline Waters, *David S. Jenkins, R. J. McNish, and Sidney Gottley*
- 118 The Age-Old Debate About a Forked Stick, *Arthur M. Sowder*

Water and Our Soil

- 121 How Water Shaped the Face of the Land, *Guy D. Smith and Robert V. Ruhe*
- 126 How Rainfall and Runoff Erode Soil, *Ben Osborn*
- 135 Valleys and Hills, Erosion and Sedimentation, *L. C. Gottschalk and Victor H. Jones*
- 144 Retention and Transmission of Water in Soil, *L. A. Richards*
- 151 How Much of the Rain Enters the Soil? *G. W. Musgrave*

Caring for Our Watersheds

- 161 Conservation Begins on the Watersheds, *Carl B Brown* and
Warren T. Murphy
- 165 A Law That Puts Responsibility at Home, *Harry A. Steele* and
Kirk M. Sandals
- 171 Floods—and a Program To Alleviate Them, *Erwin C. Ford*,
Woody L. Cowan, and *H. N. Holtan*
- 176 The Possibilities of Land Treatment in Flood Prevention,
Howard O. Matson, *William L. Heard*, *George E. Lamp*, and *David M. Ilch*
- 179 Frozen Soil and Spring and Winter Floods, *Herbert C. Storey*
- 185 Fire on the Watersheds of the Nation, *C. Allan Friedrich*
- 191 The Management of Public Watersheds, *G. R. Salmond* and
A. R. Croft
- 199 The Yazoo-Little Tallahatchie Flood Prevention Project,
William L. Heard and *Victor B. MacNaughton*
- 205 A New Song on the Muddy Chattahoochee, *Frank A. Albert*
and *Albert H. Spector*
- 210 The Story of Sandstone Creek Watershed, *Harold M. Kautz*

Water and Our Forests

- 219 Trees Also Need Water at the Right Time and Place, *G. L. Hayes*
and *Jesse H. Buell*
- 228 How To Get More Snow Water From Forest Lands, *B. C. Goodell*
and *H. G. Wilm*
- 235 Managing Forests To Control Soil Erosion, *E. G. Dunford* and
Sidney Weitzman
- 242 Soil Surveys on Forest and Range Lands, *J. L. Retzer* and
E. A. Colman

Water for Irrigation

- 247 The Expansion of Irrigation in the West, *Elco L. Greenshields*
- 252 Supplemental Irrigation in Humid Regions, *Max M. Tharp*
and *C. W. Crickman*
- 258 Surface Irrigation Methods, *John I. Phelan* and *Wayne D. Criddle*
- 267 The Use of Sprinklers for Irrigation, *Tyler H. Quackenbush* and
Dell G. Shockley
- 273 Applying Water Under the Surface of the Ground,
George M. Renfro, Jr.
- 279 Preparing Land for Efficient Irrigation, *J. G. Bamesberger*
- 285 Wells and Pumps for Irrigated Lands, *Carl Rohwer*

- 294 Pumping Ground Water So As To Avoid Overdraft, *Dean C. Muckel*
 302 Replenishing Ground Water by Spreading, *Dean C. Muckel*
 and *Leonard Schiff*
 311 Ways To Control Losses From Seepage, *C. W. Lauritzen*
 321 Irrigation Water and Saline and Alkali Soils, *Milton Fireman*
 and *H. E. Hayward*
 328 Planning a Large Irrigation Project, *John R. Riter* and
Charles LeMoyne, Jr.
 333 Water Is Where the Irrigator Finds It, *William P. Law, Jr.*,
 and *George M. Renfro, Jr.*

Water and Our Crops

- 341 Climate As An Index of Irrigation Needs, *Harry F. Blaney*
 346 The Water Budget and Its Use in Irrigation, *C. W. Thornthwaite*
 and *J. R. Mather*
 358 Soil Moisture in Relation to Plant Growth, *Cecil H. Wadleigh*
 362 How To Measure the Moisture in the Soil, *Howard R. Haise*
 372 When To Irrigate and How Much Water To Apply,
Sterling A. Taylor and *C. S. Slater*
 376 Irrigation of Tobacco, Peanuts, and Soybeans, *D. M. Whitt*
 and *C. H. M. van Bavel*
 381 Irrigating Cotton To Insure Higher Yields, *Bert A. Krantz*,
Norris P. Swanson, *Karl R. Stockinger*, and *John R. Carreker*
 389 The Irrigation and Culture of Rice, *C. Roy Adair* and *Kyle Engler*
 394 Growing 100-Bushel Corn With Irrigation, *H. F. Rhoades* and
L. B. Nelson
 400 The Irrigation of Sugar Beets, *Jay L. Haddock*

Our Ranges and Pastures

- 407 Farming Where Rainfall Is 8-20 Inches a Year, *F. L. Duley*
 and *J. J. Coyle*
 415 Management of Water on Western Rangelands, *F. G. Renner*
 and *L. D. Love*
 423 Phreatophytes—A Serious Problem in the West, *Herbert C. Fletcher*
 and *Harold B. Elmendorf*
 430 Irrigation Practices for Pastures and Forage Crops,
John R. Carreker and *James H. Lillard*
 435 Irrigation Practices for the Production of Alfalfa, *C. O. Stanberry*
 444 Development and Improvement of Coastal Marsh Ranges,
Robert E. Williams

Gardens, Turf, and Orchards

- 451 The Proper Use of Water in the Home Garden, *Victor R Boswell*
and *Marlowe D Thorne*
- 456 Irrigating Orchards in Dry Regions, *F J. Veihmeyer* and
A. H. Hendrickson
- 462 Watering Lawns and Turf and Otherwise Caring for Them,
Robert M. Hagan

Drainage of Fields

- 478 The History of Our Drainage Enterprises, *Hugh H Wooten* and
Lewis A Jones
- 491 Technical Problems and Principles of Drainage, *T W Edminster*
and *J. van Schilfgaarde*
- 499 Systems for Draining the Surface, *K. V Stewart, Jr*, and
I. L. Saveson
- 508 Tile Drainage—Its Installation and Upkeep,
Keith H Beauchamp
- 521 Outlet Ditches, Slopes, Banks, Dikes, and Levees,
John G. Sutton
- 528 The Use of Pumps for Drainage, *John G Sutton*
- 539 Drainage of Peat and Muck Lands, *John C. Stephens*
- 557 The Disposal of Seepage and Waste Water, *William W Donnan*
and *George B. Bradshaw*
- 564 Drainage in Forestry Management in the South, *E. A. Schlaudt*
- 569 Drainage in the Red River Valley of the North,
Walter W. Augustadt

Water and Our Wildlife

- 577 Planning for the Recreational Use of Water: A Plea,
John H. Sieker
- 579 Managing Watersheds To Provide Better Fishing, *Herman F Olson*,
O. H. Clark, and *D. John O'Donnell*
- 583 Making New Trout Streams in the Sierra Nevada, *Fred P. Cronemiller*
- 586 The Need of Wildlife for Drinking Water, *Lloyd W. Swift*
- 589 More Wildlife From Our Marshes and Wetlands, *Philip F. Allan*
and *Wallace L. Anderson*
- 596 Waterfowl and the Potholes of the North Central States,
Thomas A. Schrader
- 604 Wetlands and the Management of Waterfowl, *Samuel P. Shaw*
and *Walter F. Crissey*

Pure Water for Farms and Cities

- 615 The Encroachment of Salt Water Into Fresh, *Garald G. Parker*
636 Pollution—A Growing Problem of a Growing Nation, *Carl E. Schwob*
644 Treating Waste Water for Cities and Industries, *Ralph E. Fuhrman*
649 The Problems That Face Our Cities, *Harry E. Jordan*
653 The Increasing Use of Water by Industry, *Harry E. Jordan*
655 Water Supplies for Homes in the Country, *Harry L. Garver*
663 Safe Sewage Disposal for Rural Homes, *Harry L. Garver*

A Look to the Future

- 666 Regulation and Economic Expansion, *C. E. Busby*
677 Sharing the Financial Responsibility, *Roy E. Huffman*
681 Teaching and Learning About Conservation, *Charles W. Mattison*
685 What Research Is Doing on Problems of Water in Agriculture,
Carleton P. Barnes
694 Research, a Key to the Future, *Robert M. Salter and Omer J. Kelley*
701 Appendix and Index

Fair

20-Oct-1981

Drainage Manual

A Water Resources
Technical Publication

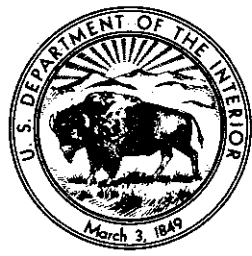

A guide to integrating plant,
soil, and water relationships
for drainage of irrigated lands.

FIRST EDITION
1978

U.S. DEPARTMENT OF THE INTERIOR
BUREAU OF RECLAMATION

CONTENTS

Preface	iii
---------	-----

CHAPTER I. INTRODUCTION

<i>Section</i>	<i>Page</i>
1-1. General	1
1-2. Scope	2
1-3. History	4
1-4. Importance	4
1-5. Benefits of drainage	4
1-6. Drainage and environment	6
1-7. Drainage nomenclature	7
(a) Surface drainage	7
(b) Subsurface drainage	7
(c) Open and pipe drains	8
(d) Deferred drainage	8
(e) Function of drains	8
(f) Inverted, relief, or pumped wells	10

CHAPTER II. BASIC DATA

2-1. Introduction	11
2-2. Topography	11
2-3. Geology	13
(a) General	13
(b) Barrier	15
(c) Aquifers	15
2-4. Soil characteristics	15
(a) Hydraulic conductivity	16
(b) Texture	18
(c) Color	18
(d) Structure	20
(e) Specific yield	23
(f) Capillary fringe	24
2-5. Salinity and alkalinity	26
(a) General	26
(b) Leaching requirement and salt balance	27
(c) Construction in sodic soils	33
(d) Classification of saline and sodic soils	34

<i>Section</i>	<i>Page</i>
2-6. Surface runoff	34
(a) Precipitation	35
(b) Stormflow	35
(c) Estimating total runoff from soil and cover conditions	39
(d) Estimating irrigation and deep percolation schedules	43
(e) Farm waste	49
2-7. Bibliography	53

CHAPTER III. FIELD AND LABORATORY PROCEDURES

A. INPLACE HYDRAULIC CONDUCTIVITY TESTS BELOW A WATER TABLE	55
3-1 Objective	55
3-2 Auger-hole test for hydraulic conductivity	55
(a) Introduction	55
(b) Equipment	55
(c) Procedure	61
(d) Calculations	63
(e) Limitations	64
(f) Step tests in layered soils	66
3-3. Piezometer test for hydraulic conductivity	67
(a) Introduction	67
(b) Equipment	67
(c) Procedure	69
(d) Calculations	70
(e) Limitations	70
3-4 Single well drawdown test for hydraulic conductivity	74
B. INPLACE HYDRAULIC CONDUCTIVITY TESTS ABOVE A WATER TABLE	74
3-5 Objective	74
3-6. Shallow well pump-in test for hydraulic conductivity	74
(a) Introduction	74
(b) Equipment	74
(c) Procedure	79
(d) Calculations	80
(e) Limitations	80
3-7 Ring permeameter test	81
(a) Introduction	81
(b) Equipment	81
(c) Procedure	85

<i>Section</i>	<i>Page</i>
(d) Calculations	92
(e) Limitations	93
3-8. Test pit method	93
(a) Introduction	93
(b) Procedure	95
(c) Calculations	95
3-9. Test for determining infiltration rate	97
C. LABORATORY TESTS FOR HYDRAULIC CONDUCTIVITY	98
3-10 Hydraulic conductivity from undisturbed soil samples	98
3-11 Hydraulic conductivity from disturbed soil samples	100
D. OBSERVATION HOLES AND PIEZOMETERS	100
3-12 Introduction	100
3-13 Location of observation holes	100
3-14 Installation of observation holes	101
3-15 Casing for observation holes	101
3-16 Piezometers	102
3-17 Installation of piezometers	102
3-18 Records of observation holes	104
3-19 Numbering system for observation holes	104
3-20 Measuring devices for depth to water	108
3-21 Plugged observation holes	111
3-22 Bibliography	111

CHAPTER IV. DRAINAGE INVESTIGATIONS

4-1. Scope of the investigations	113
4-2. Factors in an investigation	113
4-3. Review of existing data	114
4-4. Field reconnaissance	114
4-5. Subsurface investigations	115
(a) Log of drainage holes	115
(b) Projection of in-place hydraulic conductivity data to similar soil horizons	115
4-6. Identifying the barrier zone	118
4-7. Geologic influence	118
4-8. Water source studies	118
(a) General	118
(b) Precipitation	118
(c) Irrigation	119
(d) Seepage	119
(e) Hydrostatic pressure	119

<i>Section</i>	<i>Page</i>
4-9. Ground-water studies	119
(a) General	119
(b) Ground-water table contour maps	120
(c) Depth to ground water maps	120
(d) Depth to barrier maps	120
(e) Water table profiles	123
(f) Piezometric profiles	123
(g) Hydrographs	123
4-10. Ground-water accretions to drains	123
4-11. Outlet conditions	126
4-12. Drain location	127
4-13. Drain numbering	127
4-14. Existing structures	128
4-15. Economic considerations of drainage problems	128
4-16. Drainage for sprinkler irrigation	131
4-17. Tests for estimating deep percolation from sprinkler systems	132
4-18. Electric analog models: Their use in drainage problems	135
4-19. Bibliography	142

CHAPTER V. DESIGN AND CONSTRUCTION

A. SPACING OF DRAINS	143
5-1. Introduction	143
5-2. Background of the method	145
5-3. Data required	145
(a) y_0 and H	146
(b) y and Z	146
(c) Hydraulic conductivity, K	148
(d) Specific yield, S	148
(e) Time, t	148
(f) Flow depth, D	148
(g) Drain spacing, L	149
5-4. Convergence	149
5-5. Deep percolation and buildup	151
5-6. Using the data	154
5-7. Drain above the barrier layer	154
5-8. Drain on the barrier layer	159
5-9. Other uses for transient flow curves	160
5-10. Drain spacing using steady state formulas	161
5-11. Determining discharge from spaced drains	163
5-12. Design discharge for determining pipe size	165

<i>Section</i>	<i>Page</i>
B. INTERCEPTOR DRAINS	166
5-13. Interceptor drains	166
5-14. Location of first drain below an unlined canal or lateral	167
5-15. Location of first drain on irrigated sloping land	171
C. OPEN DRAINS	179
5-16. Introduction	179
5-17. Open channel flow	179
5-18. Drain velocities	182
5-19. Depth of drain	182
5-20. Drain section	183
5-21. Drain banks	183
5-22. Tributary drain intersections	184
5-23. Surface water inlets	184
5-24. Transition sections	184
5-25. Design capacities	188
5-26. Structures	188
(a) Inlets	188
(b) Drops and chutes	189
(c) Crossings	189
5-27. Natural channels	189
5-28. Stage construction	189
D. PIPE DRAINS	190
5-29. Introduction	190
5-30. Pipe for drains	190
5-31. Pipe specifications	191
5-32. Collectors	194
5-33. Depth of pipe drains	194
5-34. Grade and alinement	198
5-35. Envelope material	200
5-36. Determining hydraulic conductivity of envelope material	202
(a) Equipment	202
(b) Procedure	202
(c) Calculations	204
5-37. Gap width, length of pipe sections, and hydraulic conductivity of envelope	204
5-38. Stability of a pipe drain bed	209
5-39. Laying pipe drains	210
5-40. Inspecting and testing pipe drains	212
5-41. Backfilling pipe drain trench	213
5-42. Manholes	213
5-43. Surface inlets	214

<i>Section</i>	<i>Page</i>
5-44. Outlet structures	216
5-45. Strength of drainpipe	216
(a) General	216
(b) Rigid pipe	216
(c) Plastic tubing	220
5-46. Size of pipe	223
5-47. Capacity of pipe drains	223
5-48. Design of a drainage sump and pumping plant	223
E SPECIAL DRAIN TYPES	229
5-49. Introduction	229
5-50. Relief wells	229
5-51. Pumped wells	229
5-52. Inverted or recharge wells	229
F. INVESTIGATION AND LAYOUT FOR DRAINS	230
5-53. Introduction	230
5-54. Investigation procedure	230
5-55. Moisture holding capacity in the root zone	233
5-56. Annual irrigation schedule	234
5-57. Irrigation deliveries and deep percolation from irrigation	235
5-58. Other water sources causing high water table conditions	236
(a) Deep percolation from adjacent areas	236
(b) Deep percolation from farm ditches	238
5-59. Determination of barrier zone	239
5-60. Depth of drains	239
5-61. Drain spacing determinations and drain locations	242
5-62. Bibliography	243

CHAPTER VI. OPERATION AND MAINTENANCE OF DRAINAGE SYSTEMS

6-1. Introduction	245
6-2. Buried pipe drainage systems	245
(a) Pipe drain outlets	245
(b) Manholes or sand traps	246
(c) General maintenance of pipe drains	246
6-3. Open drainage system	247
6-4. Wastewater disposal ponds	248
6-5. Drainage observation wells	248
6-6. Policy and basic requirements	249

*Section**Page***CHAPTER VII. SPECIAL DRAINAGE PROBLEMS**

7-1. Return flow analysis using the transient flow concept	251
7-2. Bibliography	268

APPENDIX. International System (SI Metric)/U.S. Customary Conversion Tables	269
--	------------

IRRIGATION AND DRAINAGE IN THE WORLD

A GLOBAL REVIEW

by

K.K. FRAMJI

ISE (Retd.), MIE, F.I.C.E., F.Am.S.C.E., C Eng.,
Secretary-General

International Commission on Irrigation & Drainage

and

I.K. MAHAJAN

Secretary

International Commission on Irrigation & Drainage

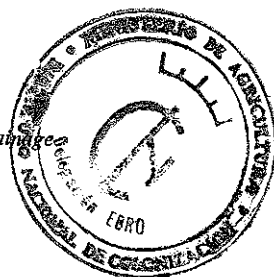

28100

Second Edition 1969

Volume I

INTERNATIONAL COMMISSION ON IRRIGATION & DRAINAGE
48, Nyaya Marg, Chanakyapuri, New Delhi-21 (India)

CONTENTS

TABLE DES MATIÈRES

VOLUME I

	<i>Page</i>		<i>Page</i>
Foreword to the Second Edition	(v)	Avant-Propos pour la Deuxième Edition	v
Foreword to the First Edition	(viii)	Avant-Propos pour la Première Edition	viii
Units of Measurements	(xciv)	Unités de Mesures	xciv
INTRODUCTION		INTRODUCTION	
Aim of Irrigation and Drainage	(xcix)	But de l'Irrigation et du Drainage	cxxvi
Irrigation	(xcix)	Irrigation	cxxvi
Drainage	(xcix)	Drainage	cxxvi
Varying Needs of Irrigation and Drainage in the World	(c)	Divers Besoins en Irrigation et Drainage dans le Monde	cxxvii
Importance of Irrigation and Drainage vis-a-vis increasing Food and Fibre Requirements of the World	(c)	Importance de l'Irrigation et du Drainage vis-a-vis Accroissement des Besoins du Monde en Aliment et en Fibre	cxxviii
Land Resources		Ressources du sol	
Improvements with Irrigation	(cii)	Amélioration par Irrigation	cxxx
Water Resources		Ressources Hydrauliques	
Surface Waters	(cv)	Eaux de Surface	cxxxii
Ground Waters	(cx)	Eaux Souterraines	cxxxvii
Irrigation Development	(cx)	Développement de l'Irrigation	cxxxvii
Drainage Development	(cxix)	Développement du Drainage	cxliii
Problems relating to Irrigation and Drainage	(cxxi)	Problèmes relatifs à l'Irrigation et au Drainage	cxlviii
Administration of Irrigation and Drainage Works	(cxxii)	Gestion des travaux d'Irrigation et du Drainage	cxlix
Appraisal of Irrigation and Drainage Works	(cxxii)	Evaluation des Projets d'Irrigation et du Drainage	cl
Financing of Irrigation and Drainage Works	(cxxiv)	Financement des Travaux d'Irrigation et du Drainage	clii
International Co-operation	(cxxiv)	Coopération Internationale	clii
General Conclusions	(cxxiv)	Conclusions Générales	clii

IRRIGATION AND DRAINAGE IN THE WORLD

A GLOBAL REVIEW

by

K.K. FRAMJI

I SE. (Retd), MIE, FICE, F Am SCE, C Eng,

Secretary-General

International Commission on Irrigation & Drainage

and

I.K. MAHAJAN

Secretary

International Commission on Irrigation & Drainage

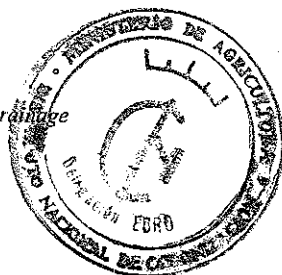

28160

Second Edition 1969

Volume II

INTERNATIONAL COMMISSION ON IRRIGATION & DRAINAGE
48, Nyaya Marg, Chanakyapuri, New Delhi-21 (India)

MODELING CROP RESPONSES TO IRRIGATION IN RELATION TO SOILS, CLIMATE AND SALINITY

R. J. HANKS AND R. W. HILL

*Department of Soil Science and Biometeorology, College of
Agriculture, Utah State University, Logan, Utah, USA*



International Irrigation Information Center

Contents

PREFACE	7
INTRODUCTION	9
LIST OF SYMBOLS	11
MODELING CROP RESPONSES TO IRRIGATION	13
Evapotranspiration Models	15
Transpiration—Available Water Models	21
Hanks model	21
Kanemasu model	41
Transpiration Model—Soil Water Flow	47
APPENDIX: FORTRAN computer coding	59
REFERENCES	65

IIIC Publication No. 1

2nd revised edition

irrigation of field
and orchard crops
under semi-arid
conditions

compiled and edited by

J. Shalhevet

A. Mantell

H. Bielorai

D. Shimshi



International Irrigation Information Center

table of contents

Introduction	1
Presentation methods	1
Experimental methods	6
Field crops	
Wheat	7
Sorghum	16
Corn	23
Cotton	30
Sugar beets	39
Peanuts	45
Alfalfa	52
Tomatoes	57
Potatoes	63
Orchard crops	
Citrus	71
Avocado	87
Apples	91
Bananas	97
Other crops	
Lawngrass	99
Greenhouse roses	104
Poplar	108
Sisal	111
Summary and Conclusions	115
Appendix	119

DESIGN OF SMALL CANAL STRUCTURES

1978

*Engineering Technology Pertaining
Primarily to the Design of Small
Canal Structures of Less Than
100-Cubic-Feet-Per-Second Capacity*

**UNITED STATES
DEPARTMENT OF THE INTERIOR
BUREAU OF RECLAMATION**

by

**A. J. Aisenbrey, Jr.
R. B. Hayes
H. J. Warren
D. L. Winsett
R. B. Young**

Denver, Colorado

Contents

	Page		Page
Preface	v		
Chapter I—General Requirements and Design Considerations		Chapter I—General Requirements and Design Considerations—Continued	
A. GENERAL REQUIREMENTS		Section	
<i>Section</i>			<i>Page</i>
1-1 Purpose	1	1-8. Lateral pressures	7
1-2. Structures	1	(a) Water	7
(a) Conveyance structures	1	(b) Earth	7
(b) Regulating structures	1	(c) Construction and operating equipment wheel surcharge	7
(c) Water measurement structures	2	(d) Ice	7
(d) Protective structures	2	(e) Wind	8
(e) Structure components and appurtenances	4	1-9. Other pressures	8
1-3. Other requirements	4	(a) Uplift	8
(a) Canal	4	(b) Hydraulic transients	8
(b) Other structures	5	(c) Seismic	8
(c) Soils exploration	5	1-10. Wheel loads transmitted to buried conduit	8
(d) Hydrology	6	(a) Highways	8
(e) Sedimentation	6	(b) Railroads	8
(f) Operation and maintenance	6	<i>2. Stability</i>	
		1-11. Bearing capacity	9
B. DESIGN CONSIDERATIONS		1-12. Sliding coefficient	9
1-4. General	6	1-13. Overturning	9
1. Loads		1-14. Percolation	9
1-5. General	7	<i>3. Hydraulics</i>	
1-6. Dead load weights	7	1-15. Hydraulic control	9
1-7. Operating deck uniform live loads	7	1-16. Hydraulic head losses	10
		(a) Friction	10
		(b) Transitions and bends	10
		1-17. Discharge coefficients	10
		(a) Orifice	10
		(b) Weir	10
		<i>4 Structural Considerations</i>	
		1-18. Reinforced concrete	10
		(a) Allowable stresses	10

Chapter I—General Requirements and Design Considerations—Continued

Section	Page
(b) Minimum reinforcement requirements	11
(c) Minimum wall thickness	11
(d) Fillets	14
(e) Cutoffs	14
1-19 Structural steel and welding	14
<i>5. Canal</i>	
1-20. Freeboard	14
1-21 Winter operation	14
1-22. Profile sheet	14
<i>6 Forms for Structures</i>	
1-23 Monolithic concrete	16
1-24 Precast concrete	16

C. BIBLIOGRAPHY

1-25. Bibliography	17
--------------------	----

Chapter II—Conveyance Structures

A. GENERAL

2-1. Purpose	19
--------------	----

B. ROAD CROSSINGS

2-2. Purpose and description	19
2-3. Application	19
2-4. Advantages	21
2-5. Design considerations	21
(a) Pipe	21
(b) Transitions	22
(c) Pipe collars	22
(d) Canal erosion protection	23
2-6. Design example	23
(a) Given	23
(b) Determine	23
(c) Check of design	24

C. INVERTED SIPHONS

2-7. Purpose and description	24
2-8. Application	24
2-9. Advantages and disadvantages of inverted siphons	26

Chapter II—Conveyance Structures—Continued

Section	Page
2-10 Structure components	26
(a) Pipe	26
(b) Transitions	27
(c) Pipe collars	27
(d) Blowoff structures	27
(e) Canal freeboard and erosion protection	28
(f) Wasteways	28
(g) Safety features	28
2-11. Hydraulic design considerations	28
2-12. Design procedure	29
2-13. Design example	29
(a) Given	32
(b) Determine	32
D. BENCH AND ELEVATED FLUMES	
2-14. Purpose and description	38
(a) General	38
(b) Bench flumes	38
(c) Elevated flumes	38
<i>1 Hydraulic Considerations</i>	
2-15. Flume section	39
(a) Ratio $\frac{b}{d}$	39
(b) Slope and velocity	39
(c) Freeboard	40
2-16. Transitions	40
(a) General	40
(b) Inlet	40
(c) Outlet	41
(d) Freeboard	41
(e) Cutoffs	41
<i>2 Structural Considerations of a Rectangular Bench Flume</i>	
2-17. Flume section	41
(a) Stability	41
(b) Wall loads	41
(c) Concrete thickness	41
(d) Drainage	41
(e) Joints	41
(f) Safety requirements	42
2-18. Design example	42
(a) Given	42
(b) Determine	42

**Chapter II—Conveyance Structures—
Continued**

Section	Page
E. DROPS	
1. <i>General</i>	
2-19 Function	48
2-20 Hydraulic design	50
2. <i>Rectangular Inclined Drops</i>	
2-21 Purpose and description	50
2-22 Advantages and disadvantages	59
2-23 Structure components	59
(a) Upstream transitions	59
(b) Inlet to drop	59
(c) Rectangular inclined channel	61
(d) Stilling pool	61
(e) Outlet	61
2-24 Percolation	61
2-25 Design example of R. I. drop with control inlet and stilling pool outlet	62
(a) Given	62
(b) Determine control inlet dimensions	62
(c) Determine hydraulic setting for stilling pool by using table 2-1	63
(d) Alternative method for determining stilling pool invert elevation	63
2-26 Design example of R. I. drop with check inlet and stilling pool outlet	64
(a) Given	64
(b) Determine check inlet dimensions	64
(c) Determine hydraulic setting for stilling pool	65
(d) Determine additional dimensions	65
3. <i>Pipe Drops</i>	
2-27 Purpose and description	65
(a) Type 1	65
(b) Type 2	65
2-28 Advantages and disadvantages	65

**Chapter II—Conveyance Structures—
Continued**

Section	Page
2-29 Type 1 pipe drop structure components	66
(a) Upstream transition	66
(b) Inlet	66
(c) Pipe	66
(d) Outlet transitions	66
2-30 Type 1 pipe drop design considerations	66
(a) Bends	67
(b) Pipe cover	67
(c) Percolation	67
(d) Freeboard	96
2-31 Type 2 pipe drop structure components and design considerations	96
(a) Baffled outlets	98
(b) Stilling pools	98
(c) Outlet transition	98
(d) Design layout	98
(e) Freeboard	98
2-32 Design example of a type 1 pipe drop with a control and pipe inlet	98
(a) Given	99
(b) Determine	99
F. CHUTES	
2-33 Purpose and description	101
1. <i>Open Channel Chute</i>	
2-34 Design considerations	104
(a) Manning's coefficient of roughness (n)	104
(b) Transitions	104
(c) Chute section	105
(d) Trajectory	105
(e) Stilling pool	106
(f) Wave formation	108
2-35 Design procedure	115
2-36 Design example	116
2. <i>Pipe Chute</i>	
2-37 Pipe chute	121
G. BIBLIOGRAPHY	
2-38 Bibliography	131

Chapter III—Regulating Structures

A. GENERAL	
<i>Section</i>	<i>Page</i>
3-1. Regulating structures	133
B. CHECKS	
3-2. Purpose and description	134
3-3. Combination structures	134
3-4. Spacing	135
3-5. Design considerations	136
(a) Stability and percolation	136
(b) Stoplogs, gates, and deck	136
(c) Head loss	136
3-6. Design example	136
C. CHECK-DROPS	
3-7. Purpose and description	139
3-8. Design considerations	139
3-9. Application	140
3-10. Design example	140
D. TURNOUTS	
3-11. Purpose and description	146
3-12. Design considerations	146
(a) Velocity	146
(b) Percolation and stability	146
(c) Hydraulics	146
(d) Miscellaneous	146
3-13. Turnouts without water measurement	146
3-14. Design example	146
3-15. Turnouts with measurement	149
(a) Flow meters	149
(b) Parshall flumes and weirs	150
(c) Constant-head orifice structures	150
3-16. Design considerations	151
3-17. Design example	154

E. DIVISION STRUCTURES

3-18. Purpose and description	162
-------------------------------	-----

**Chapter III—Regulating Structures—
Continued**

F. CHECK AND PIPE INLETS	
<i>Section</i>	<i>Page</i>
3-19. Description and purpose	166
3-20. Application	166
3-21. Design considerations	166
(a) Upstream transitions	166
(b) Protection	166
(c) Inlet opening	166
(d) Sidewalls	166
(e) Headwall	168
(f) Floor of inlet box and pipe invert	168
(g) Walk planks	168
(h) Pipe diameter	168
(i) Pipe vents	168
3-22. Structure numbering	168
3-23. Design example	168
(a) Assumptions	169
(b) Determine	169
G. CONTROL AND PIPE INLETS	
3-24. Description and purpose	170
3-25. Application	170
3-26. Design considerations	170
(a) Upstream earth transition	170
(b) Erosion protection	171
(c) Control notch	171
(d) Overflow sidewalls	171
(e) Headwall	171
(f) Width of inlet box	171
(g) Inlet invert elevation	171
(h) Pipe diameter	171
3-27. Structure numbering	171
3-28. Design example	173
(a) Given	173
(b) Determine	173

H. BIBLIOGRAPHY

3-29. Bibliography	178
--------------------	-----

Chapter IV—Protective Structures**A. GENERAL**

4-1. Purpose	179
--------------	-----

Chapter IV—Protective Structures— Continued

B. WASTEWAYS	
<i>Section</i>	<i>Page</i>
4-2. Description	179
(a) Wasteway inlets	179
(b) Wasteway outlets	180
(c) Wasteway channel and channel structures	180
(d) Appurtenant canal structures	181
4-3 Location and number	181
4-4 Wasteway capacity considera- tions	181
(a) Spillway	181
(b) Wasteway turnout gate	181
(c) Wasteway outlet	181
(d) Natural drainage chan- nels	182
4-5. Limitations	182
1. <i>Side Channel Spillways</i>	
4-6. General	182
4-7 Design considerations	182
(a) Overflow crest	182
(b) Side channel	184
(c) Wasteway turnout gate	184
(d) Pool	184
(e) Pipe	184
(f) Wasteway outlet struc- ture	185
(g) Percolation	185
(h) Protection	185
(i) Operation	185
4-8. Design example	185
(a) Assumptions	185
(b) Solution	185
(c) Check of hydraulics	187
2. <i>Gated Wasteway Turnouts</i>	
4-9. General	189
(a) Usage	189
(b) Wasteway capacity	189
(c) Types of gates	189
4-10. Hydraulics	190
(a) Inlet	190
(b) Slide gates	190
(c) Radial gates	190
(d) Trajectory	191
(e) Outlet	192

Chapter IV—Protective Structures— Continued

<i>Section</i>	<i>Page</i>
4-11. Lifts and hoists	192
(a) Manually operated lifts	192
(b) Power-operated lifts or hoists	192
(c) Hydraulically con- trolled	192
4-12. Miscellaneous considerations	192
(a) Protection	192
(b) Percolation	192
(c) Operation	192
4-13. Design example	192
(a) Assumptions	192
(b) Solution	193
3. <i>Siphon Spillways</i>	
4-14. General	195
(a) Usage	195
(b) Description	195
(c) Function	195
(d) Appurtenances	196
4-15. Design considerations	196
(a) General	196
(b) Capacity	196
(c) Head	196
(d) Entrance	197
(e) Crest	197
(f) Throat	197
(g) Downstream leg	197
(h) Siphon breaker	197
(i) Pool	197
(j) Outlet transition	197
(k) Protection	197
(l) Percolation	198
4-16. Design example	198
(a) Assumptions	198
(b) Solution	198
4. <i>Check Inlet Wasteway Turnouts</i>	
4-17. General	201
4-18. Design considerations	202
C. CROSS-DRAINAGE STRUCTURES	
4-19. General	202
(a) Siphon crossings	202
(b) Cross-drainage alterna- tives	202

Chapter IV—Protective Structures— Continued

Chapter IV—Protective Structures— Continued

<i>Section</i>	<i>Page</i>
(c) Cross-drainage capacity	203
<i>1. Culverts</i>	
4-20. General	203
4-21. Alinement	203
4-22. Profile	203
4-23. Conduit	204
4-24. Inlet	205
(a) Type 1	205
(b) Type 2	205
(c) Type 3	205
(d) Type 4	205
(e) Precast concrete transi- tions	205
(f) Earth transitions	205
4-25. Outlet	206
(a) Concrete transitions	206
(b) Outlet energy dissipa- tors	206
4-26. Hydraulics	207
(a) Design capacity	207
(b) Pipe velocity	207
(c) Pipe diameter	207
(d) Hydraulic control	207
(e) Determination of inlet or outlet control	209
(f) Inlet control hydraulics	209
(g) Outlet control hydrau- lics	209
4-27. Pipe collars	210
4-28. Protection	210
4-29. Design example	210
(a) Assumptions	211
(b) Solution	211
(c) Verification of hydrau- lics by the Bernoulli method	213
<i>2. Overchutes</i>	
4-30. General	215
4-31. Alinement	216
4-32. Profile	216
4-33. Capacity	216
4-34. Conduit	216
(a) Rectangular conduit	216
(b) Pipe conduit	218
4-35. Inlet types	218
4-36. Outlet types	218

<i>Section</i>	<i>Page</i>
(a) Concrete transitions	218
(b) Outlet energy dissipa- tors	218
4-37. Pipe overchute hydraulics	218
(a) Inlet transition	218
(b) Pipe velocity	220
(c) Pipe diameter	220
(d) Pipe outlet	220
4-38. Concrete overchute hydraulics	221
(a) Rectangular section	221
(b) Critical flow	221
(c) Inlet transition	221
(d) Chute hydraulics	221
(e) Stilling pool	222
4-39. Other considerations	224
(a) Bank heights	224
(b) Protection	224
(c) Percolation	224
4-40. Design example	224
(a) Assumptions	224
(b) Solution	225
<i>3. Drain Inlets</i>	
4-41. General	230
(a) Location	230
(b) Types	231
(c) Design capacity	231
(d) Canal bank	232
4-42. Pipe drain inlets	232
(a) Inlet	232
(b) Conduit	233
(c) Outlet	233
(d) Percolation	233
(e) Protection	234
4-43. Rectangular concrete drain inlet to earth section	234
(a) Inlet	234
(b) Flume	236
(c) Chute	236
(d) Outlet pool	236
(e) Percolation	237
(f) Protection	237
4-44. Other types of drain inlets	237
(a) Rectangular concrete drain inlets to a concrete-lined canal	237
(b) Gravel blanket drain inlet	237

Chapter IV—Protective Structures— Continued

Section	Page
4-45. Design example	237
(a) Assumptions	237
(b) Solution	238

D. BIBLIOGRAPHY

4-46. Bibliography	241
------------------------------	-----

Chapter V—Water Measurement Structures

A. GENERAL

5-1. Types of measuring structures	243
--	-----

B. PARSHALL FLUMES

5-2. Description	244
5-3. Advantages	245
5-4. Disadvantages	245
5-5. Size selection	245
5-6. Design example with free-flow discharge	246
5-7. Design example with submerged-flow discharge	247
5-8. Use of tables and figures for discharge and free-flow determinations	248
(a) Free-flow discharge	248
(b) Submerged-flow discharge	248
(c) Head losses	248

C. MODIFIED PARSHALL FLUMES

5-9. Description	259
5-10. Determination of upstream canal water surface	259

D. STILLING WELLS

5-11. Description	260
5-12. Design criteria	260

E. WEIRS

5-13. Purpose and description	260
---	-----

Chapter V—Water Measurement Structures—Continued

Section	Page
5-14. Types of weirs	260
5-15. Types of flow	261
5-16. Application	261
5-17. Adjustable weirs	262
5-18. Advantages and disadvantages	262
5-19. Requirements for accurate measurement	266
(a) Weir blade	266
(b) Nappe	266
(c) Approach channel-to-weir relationship	266
(d) Head on weir	273
5-20. Head-discharge relationship	273
(a) Rectangular and Cipolletti weirs	273
(b) V-notch weirs	273
5-21. Design example of selecting and setting a weir	273
(a) Requirements	273
(b) Weir selection	273
(c) Weir setting	273

F. WEIR BOXES

5-22. Purpose and description	291
5-23. Design considerations	291
(a) Head discharge relationship	291
(b) Head losses	291
5-24. Design example	291
(a) Solution	291

G. OPEN-FLOW METERS

5-25. Purpose and description	295
5-26. Design considerations	295
(a) Velocity	295
(b) Requirements for accurate flow measurement	295
(c) Size determination	295
(d) Head loss	295

5-27. Advantages	296
5-28. Disadvantages	296

H. BIBLIOGRAPHY

5-29. Bibliography	297
------------------------------	-----

Chapter VI—Energy Dissipators**Chapter VI—Energy Dissipators—
Continued**

<i>Section</i>	<i>Page</i>
A. GENERAL	
6-1. Energy dissipators	299
B. BAFFLED APRON DROPS	
6-2. General	299
(a) Usage	299
(b) Inlet control features	300
(c) Miscellaneous features	300
6-3. Design considerations	301
(a) General	301
(b) Capacity	301
(c) Inlet	301
(d) Baffled apron dimensions	302
(e) Uplift stability	303
(f) Sliding stability	303
(g) Miscellaneous considerations	304
6-4. Design example	304
(a) Assumptions	304
(b) Solution	304
C. BAFFLED OUTLETS	
6-5. Purpose and description	308
6-6. Hydraulic considerations	309
6-7. Sediment and debris	321
6-8. Protection	321
6-9. Basin width design procedure	321
6-10. Design example	321
(a) Given	321
(b) Determination of the basin dimensions	321
(c) Determination of erosion protection requirements	322
D. VERTICAL SLEEVE VALVE STILLING WELLS	
6-11. General	322
(a) Description	322
(b) Types of vertical sleeve valves	323
(c) Usage of vertical sleeve valve stilling wells	325
(d) Limitations	325
6-12. Design considerations	326

<i>Section</i>	<i>Page</i>
(a) Inlet conditions	326
(b) Sleeve valve design	327
(c) Hydraulic requirements	327
(d) Well dimensions	328
(e) Armor plating	330
(f) Outlet transition	330
(g) Outlet protection	330
6-13. Design example	330
(a) Assumptions	330
(b) Solution	331

E. BIBLIOGRAPHY

6-14. Bibliography	333
--------------------	-----

**Chapter VII—Transitions and
Erosion Protection****A. TRANSITIONS***1. General*

7-1. Purpose and description	335
7-2. Types	335
(a) Inline canal structure transitions	335
(b) Cross-drainage pipe structure transitions	336
<i>2. Design Considerations for Pipe Structure Transitions</i>	
7-3. Hydraulic design	336
(a) Pipe submergence	336
(b) Head losses	336
(c) Water surface angle	342
(d) Channel erosion	342
7-4. Cutoffs	342
7-5. Standardization	342
7-6. Type 1 transitions (broken-back)	342
7-7. Type 2 transition	343
7-8. Type 3 transitions	344
7-9. Type 4 transitions	344
7-10. Type 5 transitions	345
7-11. Earth transitions	345

B. EROSION PROTECTION

7-12. Purpose and description	345
-------------------------------	-----

Chapter VII—Transitions and Erosion Protection—Continued

<i>Section</i>	<i>Page</i>
7-13. Inverted siphons	345
7-14. Cross-drainage structures	347
7-15. Other structures	347

C. BIBLIOGRAPHY

7-16. Bibliography	347
------------------------------	-----

Chapter VIII—Pipe and Pipe Appurtenances

A. GENERAL

8-1. Pipe and pipe appurtenances	349
8-2. Hydraulic head losses	349

B. PIPE

8-3. Precast reinforced concrete pressure pipe	359
8-4. Precast reinforced concrete culvert pipe	359
8-5. Corrugated-metal pipe	359
8-6. Asbestos-cement pressure pipe	359
8-7. Reinforced plastic mortar pressure pipe	359
8-8. Welded steel pipe	361
8-9. Other pipe	362

C. PIPE APPURTENANCES

8-10. Pipe collars and percolation	362
8-11. Pipe bends	364
(a) Purpose and design considerations	364
(b) Bends for precast concrete pipe	365
(c) Bends for asbestos-cement pipe	365
(d) Bends for reinforced plastic mortar pipe	371
(e) Bends for corrugated-metal pipe	371
8-12. Pipe embedment	371
8-13. Pipe joints	371

Chapter VIII—Pipe and Pipe Appurtenances—Continued

<i>Section</i>	<i>Page</i>
(a) Purpose and design considerations	371
(b) Joints for precast reinforced concrete pressure pipe	371
(c) Joints for culvert pipe	372
(d) Joints for corrugated-metal pipe	373
(e) Joints for asbestos-cement pressure pipe	373
(f) Joints for reinforced plastic mortar pipe	373
(g) Joints for welded steel pipe	373
8-14. Pipe safety barrier	373
8-15. Blowoff structures	375
8-16. Air vents	375
8-17. Step-type pipe tapers	379
8-18. Pipe earthwork	379

D. BIBLIOGRAPHY

8-19. Bibliography	382
------------------------------	-----

Chapter IX—Safety

9-1. General	383
9-2. Hazard exposure classification	383

A. SAFETY DEVICES

9-3. Types	383
(a) Fencing	384
(b) Guardrails	384
(c) Warning signs	393
(d) Pipe safety barrier	393
(e) Safety nets	393
(f) Safety cables	394
(g) Safety racks	394
(h) Safety ladders	396

B. BIBLIOGRAPHY

9-4. Bibliography	398
-----------------------------	-----

MEDICION DEL AGUA DE RIEGO

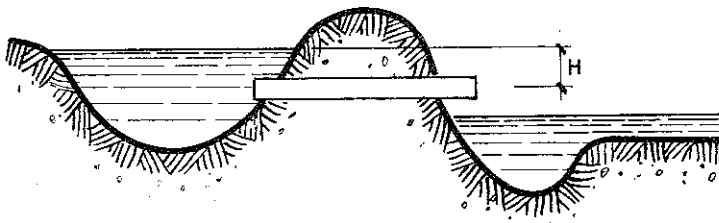
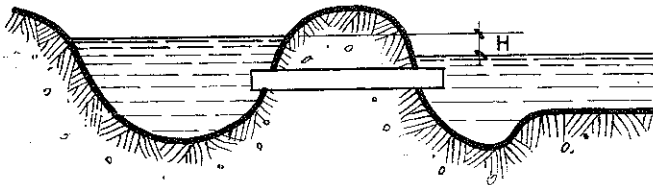
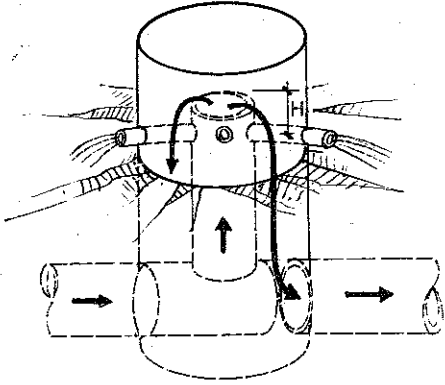

Autor: FAUSTINO GARCIA LOZANO
Jefe de Evaluación Agronómica de la
Dirección General de Obras Hidraulicas

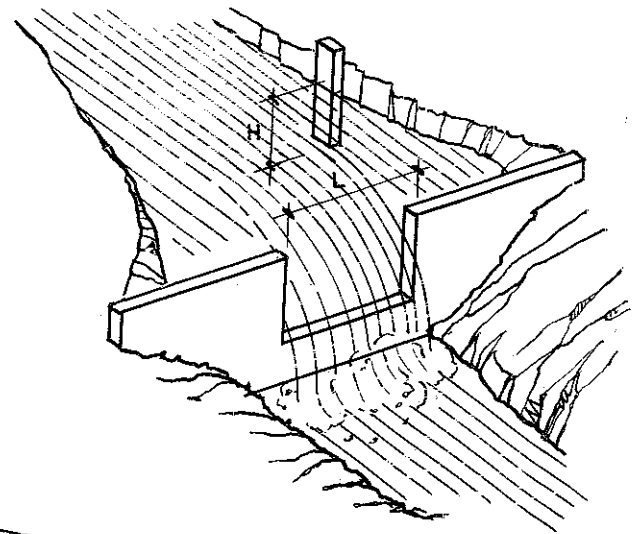
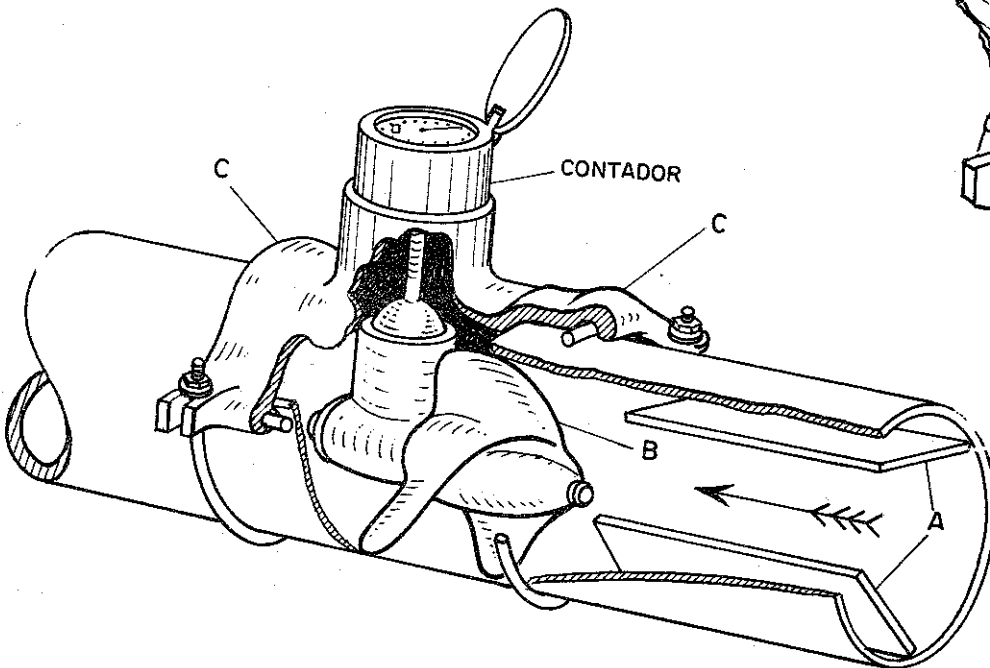

I N D I C E

MEDICION DEL AGUA DE RIEGO

	<u>PAG.</u>
INTRODUCCION.	
I.- TIPOS DISPOSITIVOS DE MEDIDA EXISTENTES	2
II.- VERTEDEROS	3
II.1.- Tipos de vertederos standard	6
II.1.1.- Normas que deben seguirse en la instalación de vertederos standard	6
II.2.- Construcción e instalación de vertederos	11
II.2.1.- Cuidados de los vertederos	13
II.2.2.- Características y dimensiones de los vertederos standard y cajones vertederos	15
II.3.- Fórmulas que proporcionan los caudales de vertido en los vertederos standard	18
II.4.- Teorías que rigen el cálculo del caudal de vertido en los vertederos standard	22
II.4.1.- Fundamento analítico de las fórmulas del caudal de vertido	23
II.4.2.- Fórmula de caudal vertido en vertederos Cipolletti .	26
II.4.3.- Fórmula de caudal de vertido en vertederos triangulares de 90°	26
II.5.- Método para medir la velocidad de aproximación de vertederos	27
II.6.- Sumergencia en vertederos	29
II.7.- Aplicación de las fórmulas para determinar el caudal de vertido en vertederos standard	31
III.- MEDIDORES PARSHALL	33
III.1.- Características del medidor Parshall	35
III.2.- Descarga en flujo libre	39
III.2.1.- Fórmulas que rigen la descarga de medidores Parshall	40

III.2.2.- Fórmulas de descarga para medidores Parshall sumergidos	43
III.3.- Medidores Parshall modificados	46
III.4.- Selección del tamaño, colocación y construcción de un - medidor Parshall	47
III.5.- Pocillos de amortiguación	55
III.6.- Modalidades o formas de medidores Parshall, transporta- bles con su campo de aplicación	56
IV.- ORIFICIOS SUMERGIDOS	56
IV.1.- Empleo de los orificios sumergidos	57
IV.2.- Tipo de orificio a emplear	58
IV.3.- Condiciones que deben tener los orificios rectangulares sumergidos para seguridad de las medidas	58
IV.4.- Dimensiones de los orificios standard sumergidos	61
IV.5.- Fórmulas que se usan en el cómputo de descarga en orifi- cios standard sumergidos	61
IV.6.- Velocidad de aproximación en las medidas con orificios - sumergidos	62
IV.7.- Correcciones para los casos de suprimir contracción en - los orificios sumergidos	63
IV.8.- Construcción y colocación de orificios sumergidos	65
IV.9.- Orificios comerciales de sumergencia ajustables	65
IV.10.- Orificios sumergidos, de altura o desnivel constante en tre la superficie del agua a la entrada y salida	66
V.- ORIFICIOS DE DESCARGA LIBRE. TUBOS DE SUMINISTRO LATERAL. SIFON CILLOS Y CANALES WSC TIPO VENTURI. MEDIDORES DE RESALTO	67
V.1.- Orificios de descarga libre	68
V.2.- Tubos de descarga lateral y sifoncillos	70
V.3.- Canales pequeños WSC, tipo Venturi	74
V.4.- Medidores de altura crítica, o de resalto hidráulico	79
VI.- DISPOSITIVOS ESPECIALES DE DISTRIBUCION Y MEDIDA AUTOMATICA DE CAUDALES EN CANALES	81
VI.1.- Distribuidores	82
VI.1.1.- Condiciones de instalación que exigen los distribuidores y fundamento de su diseño	85
VI.2.- Compuertas de nivel constante aguas arriba	87

	<u>PAG.</u>
VI.2.1. Principio de trabajo en estas compuertas	89
VI.2.2.- Condiciones de reglaje que precisa este tipo de compuertas	93
VI.2.3.- Tipos o modelos de compuertas de nivel constante aguas arriba	94
VI.3.- Compuertas de nivel constante aguas abajo	95
VI.3.1.- Principio de trabajo de estas compuertas	97
VI.3.2.- Condiciones de reglaje de este tipo de compuertas	100
VI.3.3.- Tipos o modelos de compuertas de nivel constante aguas abajo	101
VII.- METODOS ESPECIALES DE MEDIDA DE CAUDALES QUE CIRCULAN EN CANALES Y CAUCES	102
VII.1.- Medidas por flotador	103
VII.2.- Velocidad por altura de varilla	104
VII.3.- Tubo Pitot y su empleo	106
VII.4.- Método de la velocidad de sales	108
VII.5.- Método de dilución de sal	109
VII.6.- Método de velocidad por calor	110
VII.7.- Método del área de la sección y pendiente	111
VII.8.- Cómputo del caudal que descarga sobre presas o azud	112
VII.9.- Medidores de corriente	112
VII.9.1.- Condiciones para el empleo de medidores de corriente ..	116
VII.10.- Métodos para determinar velocidades medias en corrientes de agua	117
VII.11.- Fórmulas para computar el caudal que circula	118
VII.12.- Alcance de las medidas de corriente	121
VII.13.- Calibración de compuertas y esclusas	122
VIII.- METODOS DE MEDIDA EN CONDUCCIONES DE PRESION	126
VIII.1.- Tubo Pitot	126
VIII.1.1.- Modificaciones introducidas en el tubo Pitot para la medida de caudales en conducciones cerradas	130
VIII.2.- Medidor Venturi	132
VIII.3.- Boquilla de caudal	136
VIII.4.- Medidor de orificio en pared delgada	138
VIII.5.- Método de la velocidad de sales disueltas	139
VIII.6.- Método calorimétrico de velocidad	141

Climate change and sustainable development

Ethical perspectives on land use and food production

EurSAFE 2012

Tübingen, Germany

30 May - 2 June 2012

edited by:

Thomas Potthast

Simon Meisch



**Wageningen Academic
Publishers**

Table of contents

EurSafe 2012 Committees	7
Preface	17
Keynote contributions	
Domains of climate ethics: an overview <i>K. Ott and C. Baatz</i>	23
The global governance of climate change, forests, water, and food: normative challenges <i>J. Gupta</i>	29
The willed blindness of humans: animal welfare and beyond <i>M. Gjerris</i>	35
Section 1. Sustainability: general issues	
Which sustainability suits you? <i>R. Boonen, S. Aerts and J. De Tavernier</i>	43
The value(s) of sustainability within a pragmatically justified theory of values: considerations in the context of climate change <i>R. Beck, S. Meisch and T. Pothast</i>	49
Towards an ecological space paradigm: fair and sustainable distribution of environmental resources <i>W. Peeters, J. Dirix and S. Sterckx</i>	55
Section 2. Property rights and commons	
Addressing the commons: normative approaches to common pool resources <i>A. Kallhoff</i>	63
A global solution to land grabbing? An institutional cosmopolitan approach <i>K. Hoyer Toff</i>	69
Climate change, intellectual property rights and global justice <i>C.A. Timmermann and H. van den Belt</i>	75

Section 3. Global warming and climate change

Global warming, ethics, and cultural criticism <i>M. Oksanen</i>	83
The ethics of climate change denial <i>B. Gremmen</i>	90
World wide views on global warming: evaluation of a public debate <i>B. Bovenkerk and F.W.A. Brom</i>	95
The truth is that we have an inconvenient nature <i>P.F. Van Haperen, B. Gremmen and J. Jacobs</i>	100

Section 4. Ethics, adaptation & mitigation

A climate tax on meat? <i>A. Nordgren</i>	109
Acting now or later? Determining an adequate decision strategy for mitigation measures addressing methane emissions from ruminants <i>G. Hirsch Hadorn, G. Brun, C. Soliva, A. Stenke and T. Peter</i>	115
Equal per capita entitlements to greenhouse gas emissions: a justice based-critique <i>J. Dirix, W. Peeters and S. Sterckx</i>	121

Section 5. Ethics of non-agricultural land-management

Managing nature parks as an ethical challenge: a proposal for a practical tool to identify fundamental questions <i>F.L.B. Meijboom and F. Ohl</i>	131
The citizens forest model: climate change, preservation of natural resources and forest ethics <i>J.W. Simon and W. Bode</i>	137
'Good change' in the woods: conceptual and ethical perspectives on integrating sustainable land-use and biodiversity protection <i>T. Pottbast</i>	142

Section 6. Environmental & agricultural ethics

A collective virtue approach to agricultural ethics <i>P. Sandin</i>	151
Providing grounds for agricultural ethics: the wider philosophical significance of plant life integrity <i>S. Pouteau</i>	154

Do algae have moral standing? On exploitation, ethical extension and climate change mitigation 160
R.J. Geerts, B. Gremmen and J. Jacobs

Animistic pragmatism and native ways of knowing: adaptive strategies for responding to environmental change and overcoming the struggle for food in the Arctic 166
R. Anthony

Section 7. Intensive vs. extensive production: animal welfare, efficiency and environmental implications

Sustainability, animal welfare and ethical food policy: a comparative analysis of sustainable intensification and holistic integrative naturalism 175
S.P. McCulloch

'All that is solid melts into air': the Dutch debate about factory farming 181
E. de Bakker, C. de Lauwere and M. Bokma-Bakker

Adaptive capacities from an animal welfare perspective 187
D.M. De Goede, B. Gremmen, and M. Blom-Zandstra

Agriculture's 6 Fs and the need for more intensive agriculture 192
S. Aerts

Feed efficiencies in animal production: a non-numerical analysis 196
R. Boonen, S. Aerts, M. Meganck, J. De Tavernier, D. Lips and E. Decuyper

For the benefit of the land? Ethical aspects of the impact of meat production on nature, the environment and the countryside 202
C. Gamborg and M. Gjerris

Fewer burps in your burgers or more birds in the bush? 207
A. Bruce

Inconvenient truths and agricultural emissions 213
D.M. Bruce

Section 8. Agro-energy

The ethics of using agricultural land to produce biomass: using energy like it grows on trees 221
O. Shortall and K. Millar

Setting the rules of the game: ethical and legal issues raised by bioenergy governance methods 227
C. Gamborg, P. Sandøe and H.T. Anker

India's agrofuel policies from a feminist-environmentalist perspective 233
J. Rometsch

Grafting our biobased economies on African roots? <i>L. Landeweerd, P. Osseweijer, J. Kinderlerer and R. Pierce</i>	239
--	-----

Section 9. Food policy

Transformation of food governance models: perspectives arisen from a food citizenship <i>L. Escajedo San Epifanio</i>	247
Food policy and climate change: uncovering the missing links <i>V. Sodano</i>	253
Sustainable food policies for the EU27: results from the EUPOPP project <i>U.R. Fritsche, B. Brobmann, K. Hünecke, E. Heiskanen, B. Schäfer, H. Farnmler and D. Leung</i>	259
An ethical argument for vigilant prevention <i>S. Aerts, R. Boonen and J. De Tavernier</i>	267
Liability versus responsibility: the food industry case <i>T. Caspi and Y. Lurie</i>	271
Integrated assessments of emerging food technologies – some options and challenges <i>E.-M. Forsberg</i>	275
Addressing farmers or traders: socio-ethical issues in developing a national action plan for sustainable crop protection <i>J.S. Buurma and V. Beekman</i>	280

Section 10. Food in context

This is or is not food: framing malnutrition, obesity and healthy eating <i>M. Korthals</i>	289
Food as art: <i>poiēsis</i> and the importance of soft impacts <i>J. Hymers</i>	295
Conflicting food production values: global free market or local production? <i>B.K. Myskja</i>	301
Toward sustainable agriculture and food production: an ethically sound vision for the future <i>F.-T. Gottwald</i>	307

Section 11. Fish for food

- Changing an iconic species by biotechnology: the case of Norwegian salmon 315
B.K. Myskja and A.I. Myhr
- Why German consumers need to reconsider their preferences: the ethical argument for aquaculture 321
M. Kaiser
- Fish for food in a challenged climate: ethical reflections 326
H. Röcklinsberg

Section 12. Food and sustainability

- A theoretical framework to analyse sustainability relevant food choices from a cultural perspective: caring for food and sustainability in a pluralistic society 335
H. Schöler, J. de Boer and J.J. Boersema
- Food, sustainability and ecological responsibility: hunger as the negation of human rights 342
F. Javier Blázquez Ruiz
- Cultured meat: will it separate us from nature? 348
S. Welin and C. Van der Weele

Section 13. Consumers and consuming

- Gender differences in pro-social behaviour: the case of Fair Trade food consumers 355
B. De Devitiis, A.I. De Luca and O.W. Maietta
- Employing a normative conception of sustainability to reason and specify green consumerism 361
L. Voigt-Kleschin
- Are we morally obliged to become vegans? 367
S.-J. Conrad
- Food ethics: new religion or common sense? 373
E. Schmid

Section 14. Science and governance

- Climate change and biodiversity: a need for 'reflexive interdisciplinarity' 381
A. Blanchard
- Changing societies: ethical questions raised by ANR-funded research programs and projects related to climate and environmental change 387
M. de Lattre-Gasquet, P. Monfray and M. Vauclin

Examining the inclusion of ethics and social issues in bioscience research: concepts of 'reflection' in science <i>R. Smith and K. Millar</i>	394
Biochar for smallholder farmers in East Africa: arguing for transdisciplinary research <i>N. Hagemann</i>	400
 Section 15. Values for governance	
Biotechnology and a new approach to a theory of values <i>J.N. Markopoulos</i>	407
Towards a value-reflexive governance of water <i>S. Meisch, R. Beck and T. Potthast</i>	413
Mapping core values and ethical principles for livelihoods in Asia <i>S. Bremer, A.S. Haugen and M. Kaiser</i>	419
 Section 16. Biotechnology in context	
<i>Conflict cloud</i> green genetic engineering: structuring and visualizing the controversy over biotechnology in agriculture <i>C. Dürnberger</i>	427
Maize as a cultural element of identity and as a biological being: narratives of Mexican children on the transgenic maize debate and the importance of knowing the context <i>W. Cano and A. Ibarra</i>	431
Implementation of ethical standards in a cattle improvement company <i>M. De Weerd, F.L.B. Meijboom and J.S. Merton</i>	436
 Section 17. Animal ethics	
Leaving the ivory tower or back into theory? Learning from paradigm cases in animal ethics <i>H. Grimm</i>	441
From just using animals to a justification of animal use: the intrinsic value of animals as a confusing start <i>F.L.B. Meijboom</i>	447
Daniel Haybron's theory of welfare and its implications for animal welfare assessment <i>T. Višak</i>	450
Cognitive relatives yet moral strangers? Killing great apes and dolphins for food <i>J. Benz-Schwarzburg</i>	455

Assessing the animal ethics review process <i>O. Varga, P. Sandøe and I.A.S. Olsson</i>	462
Investigating the existence of an 'Animal Kuznets curve' in the EU-15 countries <i>F. Allievi and M. Vinnari</i>	468
The Chinese animal: from food to pet <i>S. Andersen Øyen</i>	475
 Section 18. Ethics teaching	
Bringing animal ethics teaching into the public domain: the Animalogos experience <i>I.A.S. Olsson, N.H. Franco and M. Magalhães-Sant'Ana</i>	483
Teaching sustainability and ethics <i>M. Steiner and B. Skorupinski</i>	489
Teaching sustainable development and environmental ethics: the IBMB-concept of bringing theory and practical cases together <i>C. Jung and B. Elger</i>	496
 Section 19. Ethical matrix and learning instruments	
The Mephram Matrix and the importance of institutions in food and agricultural ethics <i>L. Voget-Kleschin</i>	505
The ethical matrix as an instrument for teaching and evaluation <i>J. Dietrich, R. Lutz, M. Hilscher, D. Manoharan, I. Matute Giron, J. Mauser, S. Schweizer and A.C. Bellows</i>	511
Food ethics for an active citizenry: AgroFood Democracy – an active learning tool <i>I.L. Calderon, L. Escajedo San Epifanio, M. de Renobales, A. Lopez-Basaguren, M. Gorrotxategi, M. Martinez de Pancorbo, A. Rocandio, K. Millar, R. Anthony, R. González-García, S. Tarodo, P.C. Prieto, A. Jelenovic, I. Salas, A. Bernardo and M. Novo</i>	517
Author index	521
Keyword index	523

Q-5-258

No. 15066

N.M. 5582

Memoria de Actividades de

AÑO 2013

CENTRO DE
INVESTIGACIÓN Y
FORMACIÓN
AGRARIAS

CIFA

Índice

Págs.

Presentación	7
Personal	13
Actividades	19
INVESTIGACIÓN AGRARIA	21
TRANSFERENCIA DE RESULTADOS	26
FORMACIÓN AGRARIA	29
LABORATORIO AGRÍCOLA-CIFA	33
BIBLIOTECA REGIONAL AGRARIA	36
ACTOS	38
Anexo 1. Proyectos de investigación del CIFA	41
Área de Hortofruticultura	
Proyecto de experimentación con diferentes especies y variedades de arándanos; análisis físico-químico y sensorial.	43
Estudio del comportamiento agronómico de diferentes variedades de arándano (gigantes del sur, del norte y ojo de conejo o Rabbiteyes) en la Comunidad Autónoma de Cantabria.	45
Estado nutricional en el cultivo del arándano (variedad Ochlockonee).	47
Evaluación agronómica de dos cultivares de tomate injertados (Jack y Cetia) sobre patrón Beaufort, cultivados bajo cubierta, con dos sistemas de poda: a una guía o a dos guías.	49
Experimentación regional de variedades y patrones de vid, de sistemas de cultivo y de vinificación.	51
Documentación, caracterización y racionalización del germoplasma de vid prospectado y conservado en España. Creación de una colección nuclear.	53
Caracterización y evaluación agronómica y de calidad de cultivares tradicionales de tomate de Cantabria.	55
Recolección, multiplicación y caracterización de los recursos fitogenéticos hortícolas de Cantabria.	57
Prospección, selección y caracterización de germoplasma autóctono de avellano y nogal.	59
Caracterización, evaluación agronómica y calidad de conservación de cultivares tradicionales de cebolla (<i>Alium cepa</i> L.)	61
Caracterización y evaluación agronómica preliminar de judías grano tradicionales de Cantabria.	63
Cultivo de trigo sarraceno (<i>Fagopyrum esculentum</i> Moench) como alternativa agrícola en Cantabria. Agronomía, calidad y transformación.	65

Área de Calidad de los Alimentos de Origen Animal

Sistemas de producción y acabado de terneros "tipo lechal" de raza tudanca: rendimientos productivos, calidad del producto (efecto del sistema de producción y del protocolo de enfriamiento de canales ligeras) y trazabilidad de la alimentación. **67**

Influencia de los sistemas de alimentación característicos de las explotaciones productoras de leche en la cornisa cantábrica y Galicia sobre la composición de ácidos grasos de la leche. **69**

Situación nutricional del ganado vacuno lechero en producción ecológica del Norte de España: Comparación con los sistemas convencionales. **71**

Área de Sistemas de Producción Animal

Modelización de la producción de cultivos forrajeros en sistemas lecheros de la Cornisa Cantábrica e identificación de estrategias que contribuyan a la mejora de la sostenibilidad económica y ambiental de las explotaciones **73**

Producción de cultivos forrajeros de invierno en rotación con maíz. **75**

Tipificación de la ganadería de carne de Cantabria a escala municipal. **77**

Estratificación ambiental de Cantabria **79**

Muestreo de vegetación de Cantabria para la generación automática de cartografía de pastos. **81**

Área de Socioeconomía

Análisis de la sostenibilidad económica y oportunidades de mercado de sistemas alternativos de producción y acabado de terneros de raza tudanca **83**

Anexo 2. Colaboraciones Externas **85**

Análisis y mejora de modelos de simulación de cultivos en agricultura para la predicción del impacto del cambio climático y el desarrollo de estrategias de adaptación (AgMIP-wheat) **87**

Monitoreo de las actuaciones de mejora pastoral en el M.U.P. nº 394 (monte Cotalvio) propiedad del Ayuntamiento de Ruiloba. **89**

Anexo 3. Otras actividades técnico-científicas **93**

DESARROLLO RURAL Y COOPERATIVISMO AGRARIO EN ECUADOR

Trayectorias históricas de los pequeños productores en
la economía global

GERMÁN CARRILLO GARCÍA



Madrid, 2014

ÍNDICE

Prólogo, por Luciano Martínez	11
Líneas preliminares.....	15
Abreviaturas	21

PRIMERA PARTE: METAMORFOSIS DEL MUNDO RURAL

CAPÍTULO 1: La transformación del mundo rural	27
1.1. Conexiones y problemas	27
CAPÍTULO 2: Las huellas del desarrollo rural. Elaboraciones teóricas y políticas agrarias	53
2.1. Desarrollo y crecimiento: entre la teoría y la tautología	53
2.2. De la expansión colonial a la dependencia primaria	60
2.3. A la zaga de las teorías económicas	63
2.4. Tendencias historiográficas y teorías contemporáneas sobre la cuestión agraria	76
CAPÍTULO 3: Haciendas y plantaciones	93
3.1. La comunidad andina y la hacienda	97
3.2. Las discusiones sobre el colapso del régimen gamonal	102
3.3. Indios e indigenismo	106
3.4. Aparcerías, cultivos y resistencias en las plantaciones de la costa	111
CAPÍTULO 4: Reformas agrarias y cooperativismo rural	121
4.1. Reformas agrarias, contrarreformas y revolución verde	121
4.2. El cooperativismo agrario: entre el desarrollo de la comunidad y la economía de mercado	134

SEGUNDA PARTE: TRAYECTORIAS HISTÓRICAS

CAPÍTULO 5: Del modelo desarrollista de Galo Plaza a las reformas agrarias. La Colonia Agrícola Shumiral, 1950-1973	149
--	-----

5.1. Hacia la consolidación y modernización del estado ecuatoriano	150
5.2. Colonia Agrícola Shumiral: una tradición de lucha por la tierra. Los conflictos con la United Fruit Company	155
5.2.1. Cuando la United Fruit Company bajó al Sur	155
5.2.2. Los conflictos entre campesinos colonos de Shumiral y la United Fruit Company Consolidación de la Colonia Agrícola Shumiral (1956-1970)	157
CAPÍTULO 6: UROCAL: de colonia a cooperativa agrícola, 1974-1980	167
6.1. Los años setenta: entre la Segunda Ley de Reforma Agraria y el Desarrollo Rural Integral	167
6.2. UROCAL y el Grupo Pucará	179
6.3. UROCAL y el Desarrollo Rural Integral (DRI)	184
6.3.1. Modernización del mundo rural después de las reformas agrarias	184
6.3.2. UROCAL y las primeras experiencias crediticias, 1974	190
6.3.3. UROCAL y el Fondo de Desarrollo Rural Marginal (FODERUMA), 1978	195
6.4. Un primer proyecto de producción y comercialización: la secadora de cacao	206
6.5. Diversidad campesina	209
CAPÍTULO 7: Crisis en la UROCAL, 1980-1990: políticas neoliberales y territorios deprimidos	213
7.1. Ecuador en la década de 1980: el ajuste estructural	213
7.2. La crisis del cacao y el paro cacaotero: UROCAL, 1981	220
7.3. Las inundaciones del invierno de 1982-83: UROCAL ante el desastre natural	226
7.3.1. Programa artesanal y de abastecimiento	230
7.3.2. Programa de vivienda	233
7.4. Programa CEMAS (Centros para el Mejoramiento de la Alimentación y la Salud)	235
7.4.1. Consideraciones generales	235
7.4.2. Puesta en marcha del programa CEMAS: abril-agosto de 1983	239
7.5. De campesinos a mineros: la actividad extractiva en la zona de la UROCAL	247
7.6. La UROCAL y el gobierno de 'concertación' de Rodrigo Borja, 1988-1992	250
7.7. 1980, ¿Una década perdida?	262

CAPÍTULO 8: Proceso de reconversión y consolidación de la UROCAL: cultivo y comercialización agroecológica, 1992-2010	269
8.1. Ecuador: entre el neoliberalismo y el nacionalismo correista	273
8.2. El nuevo sector rural: límites y potencialidades para los pequeños productores de la UROCAL	278
8.3. Programas implementados por la UROCAL entre 1995 y 2010	284
8.4. Estudio de casos de asociaciones de base de la UROCAL	291
8.4.1. El caso de la asociación de base Asociación de Productores Nuevo Mundo, (Las Palmas, Balao, Guayas)	293
8.4.2. El caso de la Asociación de base La Florida, (Cantón Balao, Guayas)	298
8.4.3. Iniciativas de micro empresa en la UROCAL: el caso de la Asociación de base Nueva Esperanza (Naranjal, Guayas): mujeres productoras de yogurt	303
8.5. UROCAL: proyección política y social	309
8.5.1. UROCAL y el Fondo de Desarrollo Infantil (FODI): educación y participación comunitaria	317
8.6. UROCAL y la Asociación de Pequeños Productores Bananeros de El Guabo: los pequeños agricultores mercantiles frente a los agroindustriales	322
CONCLUSIONES	331
BIBLIOGRAFÍA Y FUENTES	345
APÉNDICE FOTOGRÁFICO	389
ANEXOS	401

EL GARBANZO

Un cultivo para el siglo XXI

Obra colectiva coordinada y dirigida por:

José del Moral de la Vega
Ángel Mejías Guisado

Índice de autores:

Luis E. Bernardo Carrascal

Jefe de Servicio de la Subdirección General de Cereales y Leguminosas
Ministerio de Agricultura, Pesca y Alimentación Madrid

José Enrique Campillo Álvarez

Catedrático de Fisiología Humana
Universidad de Extremadura. Badajoz

José María Carrasco López

Dr. Ingeniero Agrónomo
Servicio de Investigación y Desarrollo Tecnológico. Junta de Extremadura

José Ignacio Cubero Salmerón

Catedrático de Genética
Escuela Superior de Ingenieros Agrónomos y de Montes Córdoba

Luis López Bellido

Catedrático de Cultivos Herbáceos
Escuela Superior de Ingenieros Agrónomos y de Montes Córdoba

Manuel López Morillo

Jefe de la Oficina Comarcal Agraria de Azuaga
Servicio de Relación, Tramitación e Información Agraria Junta de Extremadura

José Lucena Navarro

Jefe de la Delegación de Agricultura
Dirección Provincial de Agricultura. Badajoz

ÍNDICE

	<u>Página</u>
PRÓLOGO	11
Capítulo 1 EL GARBANZO EN LA CULTURA ESPAÑOLA	15
Capítulo 2 EVOLUCIÓN A LO LARGO DEL TIEMPO	31
2.1. Leguminosas grano	31
2.1.1 El cultivo de las leguminosas grano en el mundo	31
2.1.2 El cultivo de las leguminosas grano en España	32
2.2 El garbanzo	34
2.2.1 Cultivo del garbanzo en el mundo	34
2.2.2 Cultivo del garbanzo en España	35
2.2.3 Cultivo del garbanzo en Extremadura	39
2.3 Consumo de las leguminosas grano	42
Capítulo 3 EL FUTURO DEL CULTIVO	47
Capítulo 4 AGRONOMÍA DEL GARBANZO	52
4.1 Economía del garbanzo en España	52
4.2 Garbanzo de siembra de primavera	55
4.2.1 Variedades	55
4.2.2 Densidad de plantas	56
4.2.3 Abonado fosfórico	58
4.3 Garbanzo de siembra invernal	58
4.3.1 Ensayos de ICARDA	60
4.3.2 Control de malas hierbas	61
Capítulo 5. EXPERIENCIAS AGRONÓMICAS REALIZADAS EN EXTREMADURA	62
Capítulo 6 REFLEXIONES SOBRE ALGUNOS ASPECTOS DE MEJORA GENÉTICA	68
Capítulo 7 RESULTADOS DE LA MEJORA GENÉTICA REALIZADA EN EXTREMADURA	71
Capítulo 8 APROXIMACIÓN A LOS ESTADOS FENOLÓGICOS DEL GARBANZO	78
Capítulo 9 ENFERMEDADES DEL GARBANZO EN INVIERNO: RABIA Y MUERTE DE PLÁNTULAS	83
9.1 Introducción	83
9.2 La Rabia del garbanzo	84
9.2.1 Sintomatología	84
9.2.2 Agente causal	85
9.2.3 Ciclo biológico	86
9.2.4 Control	86
- Resistencia	87
- Restos de cultivo	89
- Semillas libres de patógenos	90
- Otras medidas de lucha	90
9.3. La muerte de plántulas	91

	9 3 1 Sintomatología	91
	9 3 2 Agente causal y condiciones favorables	92
	9 3 3 Control	92
	9 4 Otras enfermedades	92
	9 5 Control integrado	93
Capítulo 10	PROGRAMA DE SANIDAD	95
	10 1 Introducción	95
	10 2 Programa de sanidad para las siembras de otoño-invierno	98
	10 3 Programa de sanidad para las siembras de final de invierno	100
	10 4 Otras consideraciones	103
Capítulo 11	MODELO ACTUAL DEL CULTIVO EN LA CAMPIÑA SUR DE EXTREMADURA	105
	11 1 Labores	105
	11 2 Alternativas	106
	11 3 Tratamiento de semillas	106
	11 4 Herbicidas	106
	11 5 Abonado	107
	11 6 Siembra	107
	11 7 Dosis de siembra	107
	11 8 Maquinaria para siembra	108
	11 9 Tratamientos	108
	11 10 Recolección	108
	11 11 Defectos habituales en la recolección mecanizada y posibles causas	109
	11 12 Producciones	110
Capítulo 12	CALIDAD DEL GARBANZO PARA CONSUMO HUMANO	111
	12 1 Índices de calidad. Principios generales	111
	12 2 Relaciones entre índices de calidad	113
	12 3 Influencia del clima	114
	12 4 Influencia del suelo	118
Capítulo 13	LOS GARBANZOS Y LA DIETA MEDITERRÁNEA	122
Capítulo 14	AYUDAS DE LA UE AL CULTIVO	127
Capítulo 15	EL CONTRATO, UN INSTRUMENTO IMPORTANTE EN LA REGULACIÓN DEL MERCADO DEL GARBANZO	130
Anejo 1	COLOQUIO REALIZADO ENTRE CONFERENCIANTES Y ASISTENTES A LAS JORNADAS SOBRE TECNOLOGÍA DEL GARBANZO DESARROLLADAS EN ZAFRA EN MAYO 1994	135
Anejo 2	VARIETADES DE GARBANZO REGISTRADAS EN ESPAÑA	139
Anejo 3	CONTRATO DE COMPRA-VENTA DE GARBANZO HOMOLOGADO POR EL MAPA	140
Anejo 4	DIRECTORIO DEL SECTOR DE LEGUMBRES CON ESPECIAL REFERENCIA AL GARBANZO	147
	ÍNDICE ALFABÉTICO	171
	AGRADECIMIENTOS	175

1^{er} CONGRESO TECNOLÓGICO DEL TOMATE PARA INDUSTRIA

12-13-NOVIEMBRE
Palacio de Congresos
de Badajoz "Manuel Rojas"

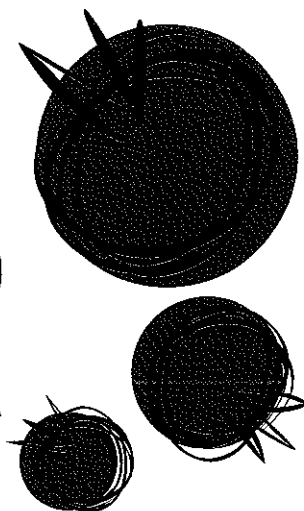

Organiza:

OBSERVATORIO
TECNOLÓGICO
DEL TOMATE

Plataforma Tecnológica del Sector
de Tomate de Industria

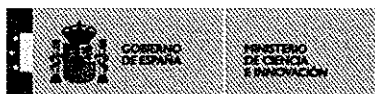

Publicaciones de la
Secretaría General

JUNTA DE EXTREMADURA
Consejería de Agricultura y Desarrollo Rural

ÍNDICE

	Página
Prólogo	13
Póster Sección 1: Mejora de la calidad comercial de la materia prima básica de las industrias del tomate	15
Characterizing spatial distribution of <i>Sorghum halepense</i> in tomato cropping fields.....	17
Influence of organic fertilizers and irrigation development on physical parameters in 'nautilus' tomato fruits	19
Efecto de diferentes dosis de riego y mantenimiento de suelo, sobre los parámetros productivos y de calidad en una rotación hortícola	21
Evaluación de variedades de tomate de industria con alto contenido en licopeno	23
Estudio de la eficiencia de diferentes tratamientos herbicidas en el cultivo del tomate de industria	25
Diferenciación de variedades de tomate raf mediante tecnología de infrarrojo cercano (nir)	27
Effects of response oxidative produced by dry olive residue on seedlings root of <i>Solanum lycopersicum</i>	29
Contribución de la mejora genética al incremento de la producción y la mejora de la calidad en el tomate de industria	31
Estudio de las capturas en trampas con feromonas sexuales de <i>Helicoverpa armigera</i> hübner (<i>Lepidoptera noctuidae</i>) en las variables color de trampa y margen del río, en las vegas bajas del río guadiana	33
Estudio de los parámetros de color de dos nuevas variedades de tomate industrial (pata roja y top-20).....	35
Medida de los parámetros del color y correlación con la concentración de licopeno en tomate de industria.....	37
La fecha de trasplante como factor determinante del contenido en licopeno y otros parámetros de calidad y producción en tomate de industria	39
Influencia del genotipo (cultivar) y de la dosis de riego en el contenido en licopeno del tomate de industria.....	41
Parámetros de calidad de cultivares de tomate (<i>Lycopersicum esculentum</i> mill.) de interés industrial e influencia de la dosis de riego	43
Licopeno y tomate de industria. Influencia varietal en cultivo en el valle del ebro.....	45
Estudio del comportamiento agronómico y tecnológico de nuevas variedades de tomate de industria	47
Influencia de la fecha de trasplante en la cosecha del tomate de industria en extremadura.....	49
Influencia de diferentes prácticas agrícolas en la producción de tomate ecológico.....	51
Localización de fragmentos de ADN de <i>Solanum galapagense</i> en genotipos mejorados de tomate	53
Riego deficitario en tomate para industria	55
New and robust method for the control of pesticide residues in tomatoes and derived products Food safety	57
Evaluación de variedades comerciales de tomate de industria en siembra temprana en las Vegas Bajas del Guadiana	59
Evaluación de variedades comerciales de tomate de industria en siembra media en las Vegas Bajas del Guadiana	61

	<u>Página</u>
Póster Sección 2: Mejora de la calidad de los semielaborados de tomate y de la eficiencia de los procesos	63
Estudio comparativo del efecto del tratamiento de zumo de tomate con pulsos eléctricos o calor sobre color, viscosidad y las enzimas relacionadas.....	65
Mejora de la textura y rendimiento del tomate en dados mediante el uso de enzimas	67
Póster Sección 3: Aprovechamiento de subproductos de tomate	69
Desarrollo de salsas de tomate adicionadas con licopeno	71
Comportamiento del secado convectivo en capa fina de subproductos de industrias tomateras a bajas temperaturas.	73
Aprovechamiento de subproductos de la industria de tomate para alimentación de corderos.	75
The extraction of the solid phase of tomato samples before the f-c method to reduce interference	77
Póster Sección 4: Desarrollo de nuevos productos secundarios	79
Efecto de la incorporación de fibra de tomate sobre el color y la oxidación de lípidos y proteínas de un producto cocido de pollo	81
Identificación, caracterización y optimización de starters de fermentación mediante combinación de técnicas analíticas y moleculares. Aplicación al proceso de obtención de vinagre a partir de subproductos de cereza y tomate	83
Efecto de la incorporación de fibra de tomate en hamburguesas de cerdo ibérico sobre el color y la estabilidad oxidativa durante el almacenamiento refrigerado	85
Póster Sección 5: Desarrollo de nuevos procesos y productos a partir de otras materias primas.	87
Evaluación sensorial de muestras de productos finales de tomate procedentes de la agricultura ecológica.....	89
Evaluación sensorial de muestras de semielaborados de tomate procedentes de la agricultura ecológica.....	91
Efecto sobre el color de tratamientos agrícolas en tomate ecológico	93
Estudio comparativo de firmeza de tomate dados procedente de agricultura convencional y ecológica	95
Estudio comparativo de la textura de tomate fresco procedente de agricultura convencional y ecológica	97
Análisis de contraste de la textura de tomate ecológico con diferentes tratamientos agrícolas.....	99
Estudio de la influencia de la climatología en los parámetros agronómicos y tecnológicos del tomate de industria	101
Póster Sección 6: Transferencia tecnológica	103
La red andaluza de experimentaciones agrarias (RAEA) en tomate para industria.....	105
Auditoría energética en una industria tomatera extremeña	107
El COTR en la transferencia de la tecnología de regadío	109
Caracterización de las OPFH de tomate en extremadura	111
Evolución del consumo nacional en hogares de derivados de tomate entre 2004-2008	113
Aportaciones de nuestro grupo de investigación al desarrollo de la industria del tomate.....	115
Participantes	117

Plagas y enfermedades en hortalizas y frutales ecológicos

Prevenir, identificar y tratar con métodos ecológicos

Xavi Fontanet i Roig y Andreu Vila Pascual

Editado por

la Fertilidad
de la Tierra

Índice



INTRODUCCIÓN LA SALUD EN LA FINCA

Invitar a la Naturaleza a equilibrar el ecosistema	14
Bases ecológicas del equilibrio	14
A modo de ejemplo práctico	17

PARTE PRIMERA. ESTRATEGIAS PARA UNA REGULACIÓN NATURAL

Cómo incorporar las estrategias	20
Diseño de la finca y reservorios de biodiversidad	21
Diseño de los setos	22
Beneficios de los setos	22
Especies arbóreas y fauna auxiliar	23
Bandas florales	24
Las mejores plantas para atraer y acoger fauna útil	24
Plantas con altas poblaciones de insectos auxiliares	25
Cajas nido, comederos y reposaderos	25
Plantas refugio para el control de diferentes plagas sobre cultivos hortícolas	26
Refugios y hoteles de insectos	27
Ejemplos de hábitats para algunos insectos auxiliares contra plagas	28
Charcas vivas	29
Diseño de los cultivos	30
La elección de especies y variedades	30
Valores de las variedades locales frente a las modernas	30
Abonos verdes interesantes en la rotación frente a plagas y enfermedades	32
Rotaciones de cultivos y abonos verdes	33
Cultivos sembrados como abono verde	34
Asociaciones y policultivos	36
Asociaciones y control de plagas	37
Cubiertas herbáceas	38
Buenas prácticas de cultivo	40
Manejo de la tierra	40
Abonado	41
Riego	42
Las semillas y el plantel	44
Levantar o retirar el cultivo	46
En el momento de la plantación y el crecimiento	46
Higiene y precauciones	47
Observación, seguimiento y toma de decisiones	48

Índice

Métodos de control de plagas		51	
Técnicas de descontaminación		51	
Solarización: hongos y nematodos controlados en experiencias de campo		52	
Biofumigación: patógenos controlados en experiencias de campo		53	
Métodos físicos		54	
Captura masiva		57	
Confusión sexual		59	
Control biológico dirigido		60	
Tratamientos		62	
SEGUNDA PARTE. PLAGAS Y ENFERMEDADES EN HORTALIZAS		66	
Compuestas		66	
Lechuga, escarola, alcachofa			
Pulgones	68	Moho gris	73
Pulgones de las raíces	69	Puntas quemadas	74
Orugas defoliadoras	69	Podredumbre blanca del cuello	74
Barrenador de la alcachofa	70	Podredumbre del cuello	75
Caracoles y babosas	71	Verticilosis	76
Mildiu	71	Virosis	76
Oídio o ceniza	72	Subida a flor prematura	77
Oidiopsis o blanqueta	73	Necrosis apical o tip burn	77
 			78
Crucíferas			78
Col, coliflor y brócoli, coles de Bruselas, berzas, col china, nabo, colinabo o nabicol, rábano, colirrábano			
Pulgón harinoso de la col	80	Pulguilla de las crucíferas	84
Orugas	81	Mildiu	85
Mosca blanca	82	Potra o hernia de la col	85
Mosca de la col	83	Podredumbre negra	86
Chinchas de las crucíferas	83	Subida a flor prematura	86
 			87
Cucurbitáceas			87
Calabacín, pepino, melón, sandía, calabaza			
Pulgones	89	Podredumbre gris	96
Araña roja	90	Podredumbre blanca del cuello	97
Trips de las flores	91	Podredumbres de cuello y raíz	97
Orugas	92	Virus	98
Mosca blanca	93	Chupado de frutos	99
Mosca minadora	94	Ennieblado de frutos	99
Oídio o ceniza	95	Planchado de frutos	99
Mildiu	95	Agrietado de frutos	99

Fabáceas			100
Judía, alubia, haba, guisante			
Polilla del grano	102	Podredumbre gris	111
Mosca de los sembrados	103	Mildiu	111
Pulgones	103	Podredumbre blanca	112
Mosca blanca	105	Podredumbres de cuello y raíz	113
Orugas defoliadoras	105	Oídio o ceniza	113
Araña roja	106	Grasa de la judía	114
Araña blanca	107	Virus	115
Mosca minadora	107	Jopo	115
Trips	108	Caída de flores	116
Sitonia	109	Amarilleo y marchitamiento de la judía	116
Rabia o antracnosis	109		
Roya	110		
Gramíneas			117
Maíz			
Araña roja	117	Carbón	120
Pulgones	118	Mal llenado de mazorcas	120
Orugas y taladros	119		
Liliáceas			122
Ajo, cebolla, puerro			
Mosca de la cebolla	123	Roya	126
Trips de la cebolla	123	Subida a flor prematura o "encañonado"	126
Tiña o polilla del puerro	124		
Mildíu	125		
Plantel y plántulas hortícolas			127
Gusanos o rosquillas grises	128	Ahiñado	132
Gusano del alambre	129	Asfixia radicular	132
Caída de plántulas o damping-off	130	Salinidad por sobreabonado	132
Insectos transmisores de virosis	131		
Quenopodiáceas			133
Acelga, espinaca, remolacha			
Pulgón negro	134	Pulguilla o altica de la remolacha	136
Orugas	135	Mildiu	137
Mosca minadora de la remolacha	136	Cercospora	138

Índice

Rosáceas			139
Fresa y fresón			
Mosca de los pequeños frutos	140	Oídio o ceniza	144
Pulgones	141	Podredumbre gris	144
Araña roja	142	Podredumbre de cuello y raíz	145
Trips de las flores	142	Verticilosis	146
Orugas	143	Clorosis férrica	146
Solanáceas (I)			147
Tomate y pimiento			
Tuta	149	Seca o tristeza del pimiento	160
Heliothis o gusano del tomate y otras orugas	150	Alternariosis	160
Pulgones	151	Podredumbres de cuello y raíz	161
Mosca blanca	153	Fusariosis vascular	162
Araña roja	154	Mancha negra bacteriana	163
Araña blanca	155	Nematodos	163
Vasates o bronceado parasitario	155	Virus	164
Mosca minadora	156	Necrosis o podredumbre apical de frutos	165
Trips de las flores	157	Asolado o planchado de frutos	166
Mildiu	158	Agrietado del fruto	166
Oidiopsis	159	Enrollamiento de hojas	166
Solanáceas (II)			167
Patata, berenjena			
Escarabajo de la patata	169	Sarna común	174
Gusano del alambre	170	Nematodo del quiste	175
Polilla de la patata	171	Virus	175
Verticilosis	172	Toxicidad por ozono	176
Viruela de la patata	173	Enverdecimiento de tubérculos	176
Alternariosis o negrón	173	Ahilado	176
Umbelíferas			177
Zanahoria, apio, hinojo			
Mosca de la zanahoria	179	Picado o cavity-spot	183
Mosca minadora del apio	179	Podredumbre blanca del cuello	183
Gusano del alambre	180	Tizón o manchas foliares	184
Pulgón	181	Nematodos	185
Oidiopsis	182	Raíces agrietadas	185
Quemadura de hojas o alternariosis	182		

TERCERA PARTE. PLAGAS Y ENFERMEDADES EN FRUTALES

Cítricos			188
Naranja, mandarina blanca y clementina, limón, pomelo			
Mosca de la fruta o mosca del Mediterráneo	189	Ácaros	195
Pulgones	190	Mosca blanca algodonosa de los cítricos	196
Piojos y serpetas	191	Gomosis	197
Cochinillas o caparretas	192	Virus de la tristeza de los cítricos (ctv)	198
Cotonet	193	Caida de frutos pequeños o <i>porgà</i>	198
Minadora de las hojas de los cítricos	194		
Frutales de hueso			199
Melocotonero, ciruelo, cerezo, albaricoquero			
Oruga o polilla de los frutales de hueso	204	Ácaro plateado del melocotonero	218
Mosca de la fruta o mosca del Mediterráneo	205	Mal del plomo	218
Mosca de la cereza o ragoletis	206	Abolladura	219
Drosophila de la cereza	207	Oídio	219
Pulgones	208	Monilia	220
Pulgón negro de la madera	209	Roya	221
Hoplocampa	210	Cribado o perdigonado	221
Trips	211	Cilindrosporiosis del cerezo	222
Mosquito verde o empoasca	212	Chancros de los frutales	222
Taladro rojo del tronco o cossus	212	Mal de cuello o phytophthora	223
Tigre del almendro	213	Mal blanco de las raíces y podredumbre radicular rosellinia y armilaria	223
Minadora sinuosa	214	Agrobacterium	224
Piojo de San José	214	Xanthomonas	224
Piojo blanco	215	Enfermedades de post-cosecha	225
Gusano cabezudo o capnodis	216	Virus y fitoplasmas	226
Acalitus o ácaro de las agallas del ciruelo	216	ESFY o fitoplasma del ciruelo	227
Araña roja	217	Rajado del fruto o cracking	227
Olivo			229
Mosca del olivo	230	Barrenillo del olivo	234
Prays o polilla del racimo	231	Repilo u ojo de pavo/gallo	235
Glifoides o polilla del jazmín	232	Verticilosis	236
Cochinilla o caparreta negra o de la tizne	233	Tuberculosis o roña	237

Índice

Frutales de pepita			238
Manzana, pera, membrillo			
Carpocapsa	242	Erinosis	255
Mosca de la fruta o mosca del Mediterráneo	243	Moteado	255
Mieleta o psila del peral	244	Oidio	256
Pulgones	245	Monilia	257
Hoplocampa	246	Stemphylium o mancha negra	258
Capua o pandemis	247	Antracnosis	258
Gorgojo de la flor del manzano	248	Roya	259
Minadora circular	249	Chancros de los frutales	259
Cigarrero o perrisia	249	Mal de cuello o phytophthora	260
Picabrottes del peral	250	Rosellinia – armilaria	260
Barrenador de la madera o zeuzera	251	Pseudomonas	261
Taladro rojo del tronco o cossus	251	Fuego bacteriano	261
Barreno de la corteza o sesia	252	Virus y fitoplasmas	262
Tigre del peral	252	Enfermedades de post-cosecha	263
Piojo de San José	253	Bitter pit o plara	263
Araña roja	254	Golpe de sol	264
		Cracking o rajado del fruto	264
		Russeting	265
Vid			266
Gusano o polilla del racimo	267	Podredumbre gris	271
Erinosis	268	Enfermedades de madera:	
Oídio o ceniza	269	Eutipia y yesca	272
Mildiu	270	Corrimiento de la uva	272
ANEXOS			
Artrópodos auxiliares			276
Animales vertebrados de interés			288
Productos utilizables en agricultura ecológica			294
Listado de algunas especies de árboles y arbustos interesantes para formar setos			306
Tabla para construir uno mismo cajas nido, con dimensiones según especies			310
Órdenes de artrópodos de interés agrícola			311
Bibliografía y recursos			323
Índice alfabético de nombres comunes y científicos			324

	<u>PAG.</u>
VIII.7.- Método Californiano de la tubería	142
VIII.7.1.- Dispositivo para la medida de la altura del agua en - el extremo de la conducción	144
VIII.7.2.- Medida por orificio instalado en final de la conduc- ción	144
VIII.8.- Método de contadores de agua o de medida volumétrica di recta	146
VIII.8.1.- Tipos de medidores volumétricos de agua	149
VIII.9.- Método de las coordenadas del chorro	153
VIII.9.1.- Fundamento del método de medida de las coordenadas -- del chorro o de la trayectoria	161
IX.- NORMAS DE MEDIDA QUE RIGEN EL EMPLEO DE VERTEDEROS SEGUN EL INS- TITUTO HIDRAULICO DE CODIFICACION EN ENSAYOS DE E.U.A.	166

MIRAR EL PAISAJE PARA CONTEMPLAR NUESTRA HISTORIA

100 años de cambios en el paisaje de Riegos del Alto Aragón

Presentación	06
Introducción	07
01 El proyecto de Riegos del Alto Aragón. La intención de transformar el paisaje	16
02 Infraestructuras hidráulicas de regulación y transporte	42
03. Puesta en regadío. Cambios en el parcelario y en la topografía	72
04. Redes: acequias, desagües y caminos	98
05. Cultivos	114
06 Sistemas de riegos y modernización de regadíos	146
07 Nuevos núcleos de población	168
08. Impactos asociados	184
Bibliografía y documentación	205
Créditos fotográficos	206